

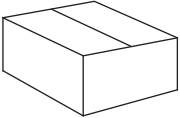











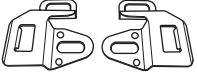





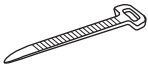

INSTALLATION PARTS

1  Installation kit box 1 pc. C-130043	2  Sponge rubber edge 1 roll. C-020494-04T	3  Kwick klamp S6 1 set. C-120490-02	4  Kwick klamp cover 6 pcs. C-100597-01BL	5  Latch STL S-5 R/L 1 pair. C-110060
6  Double bolt M8x33 SUS 2 pcs. C-120108S	7  PVC Double bolt washer 2 pcs. C-020221V	8  Nut M8 SUS 4 pcs. C-030645	9  AL adjustable shim for latch 2 pcs. C-110160	10  Shock STABILUS GAS 2 pcs. C-160204
11  Weather strip 1 roll. C-020132	12  Screw 2 pcs. C-030059	13  CARRYBOY SR5 LOGO 2 pcs. C-160416-01	14  Wiring harness 1 set. C-090432-02(Front) or C-090437-06(Rear)	15  Box switch 1 pc. C-100530
16  Cable tie 5.5" 15 pcs. C-130046	17  Electric klamp lock 4 pcs. C-160259	18  Installation manual 1 set. C-132701-03	19  Check list 1 pc. CL-280045-05	

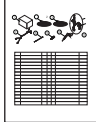
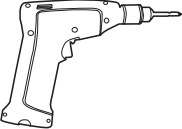
INSTALLATION TOOLS

 Screw Driver	 Torque Wrench No.13	 Wrench No.13	 Cutter	 Measuring tape
---	--	---	---	---

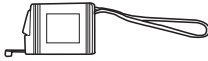
1 Clean the edge of truck bed.

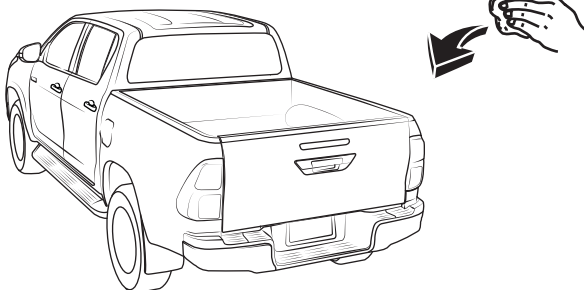

2 Clean of under the hardtop.

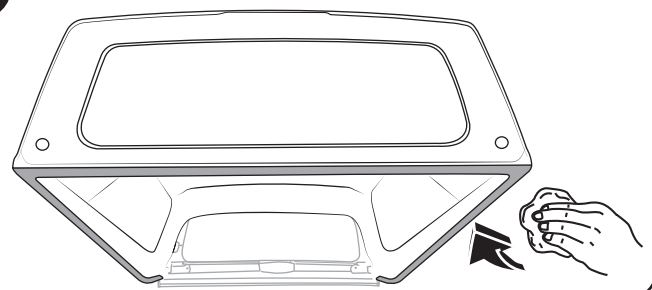

3 Install rubber truck edge under the hardtop.

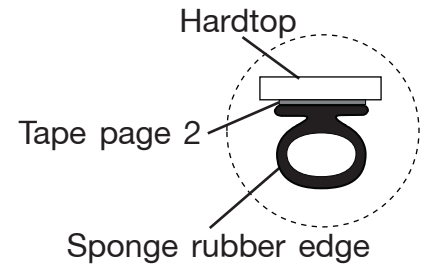
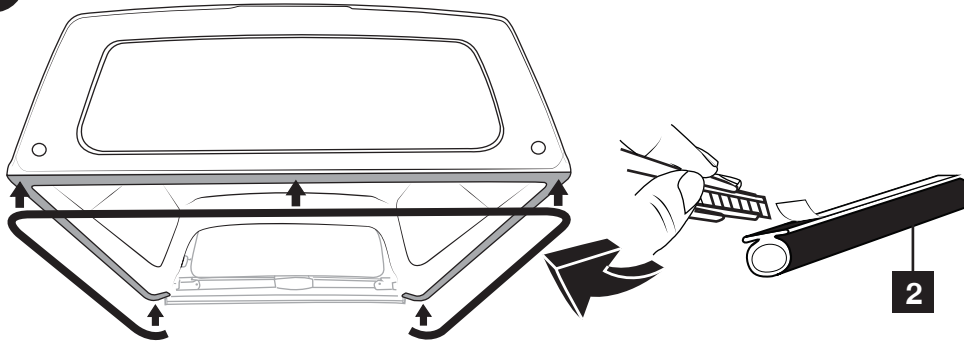

4 Place hardtop on the truck bed and adjust alignment between left and right.

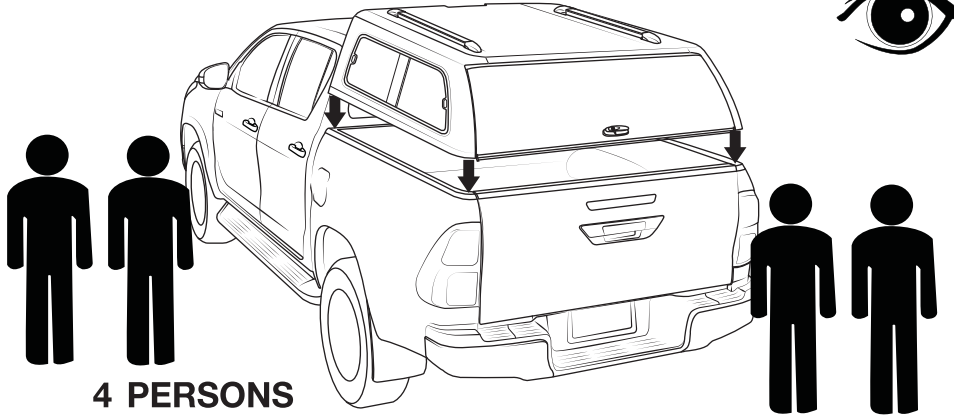

4 PERSONS

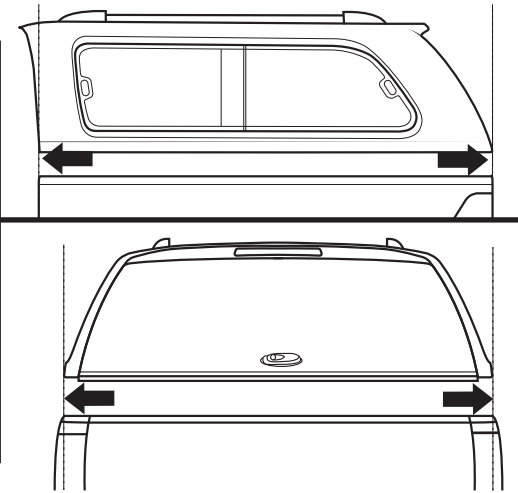

5 Install kwick klamp for 6 positions.

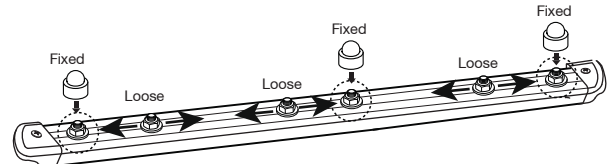
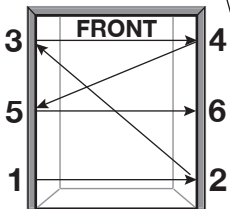
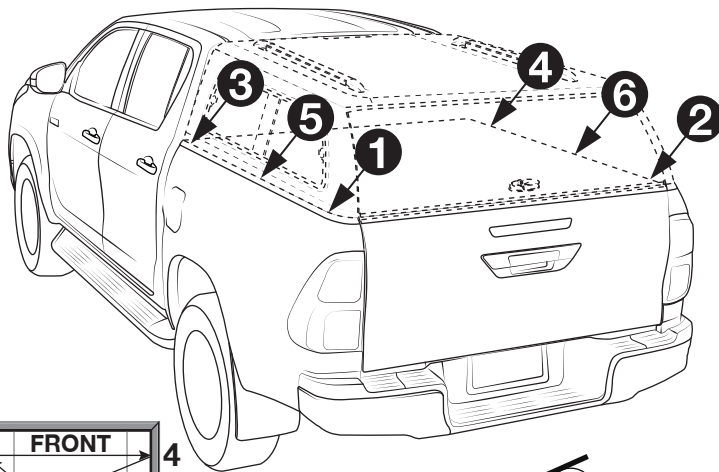

5A Adjust the position to fix loose bolts on the Al. rail. (Remarks : In case of having bed liner, Al. Klamp must be fixed at the flat area of the bed liner)

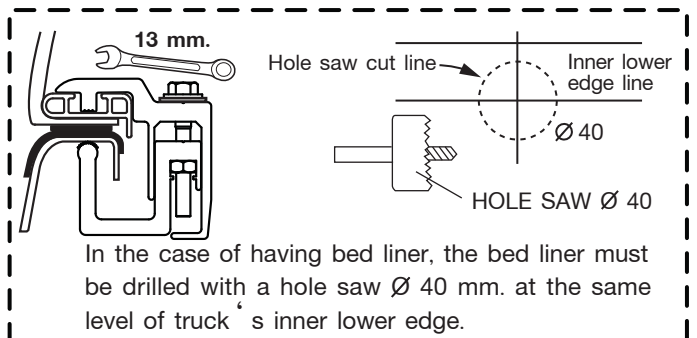

In the case of having bed liner, the bed liner must be drilled with a hole saw Ø 40 mm. at the same level of truck's inner lower edge.

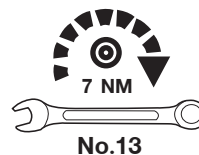

5B Remove the nut's spring washer and washer from 3 loose bolts. Then, put the upper Al. clomp klamp on the Al. rail through the hole on the top of upper Al. klamp. Tighter nuts, spring washer and washer back to its original position to lock the upper Al. klamp.

5C Put the lower Al. klamp through the bolt M8x70 follow the diagram. Then, tighten the lower Al. klamp with truck's inner lower edge and bolt M8x70.

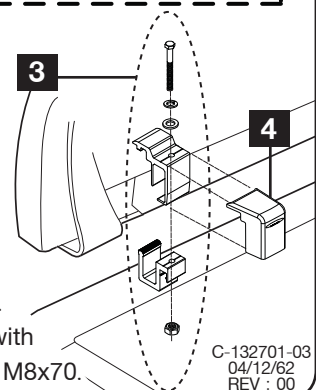

6 Installing latch R/L on the rear door.

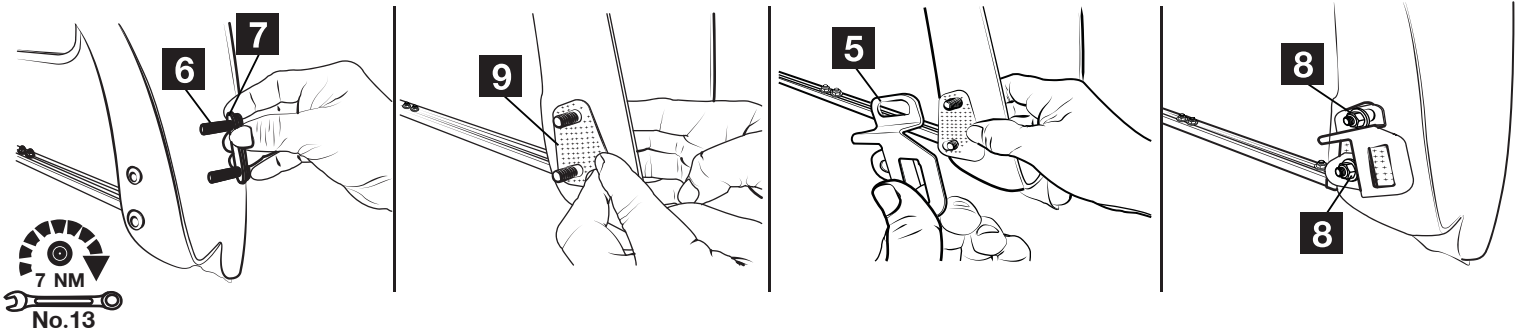

7 Adjust a latch R/L for matching with the slam lock on the rear door.

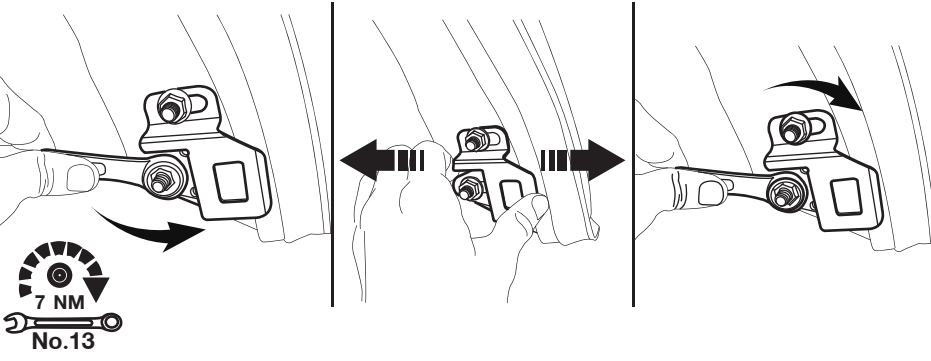

8 Shock absorber assembly.

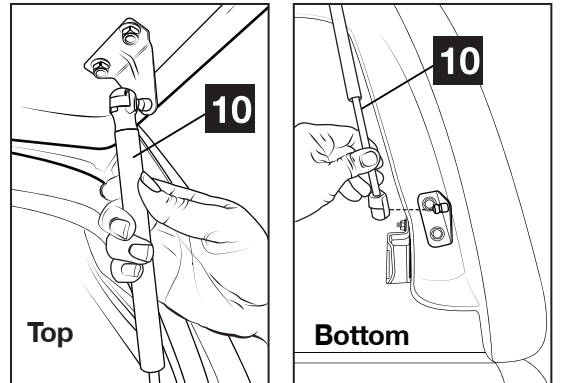

9 Final check the appearance.

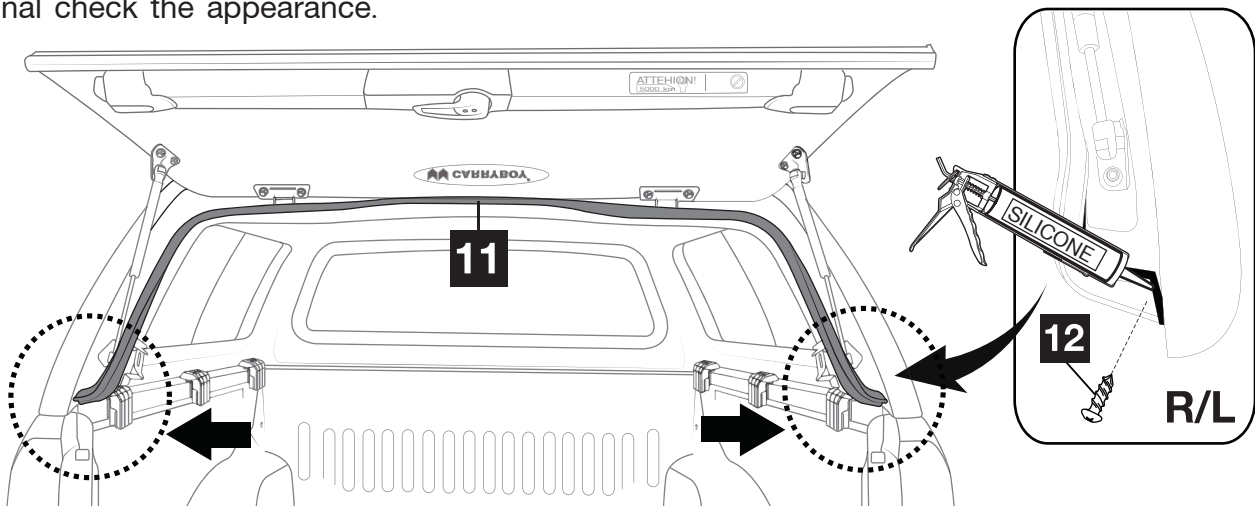

10 Stick CARRYBOY resin sticker R/L.

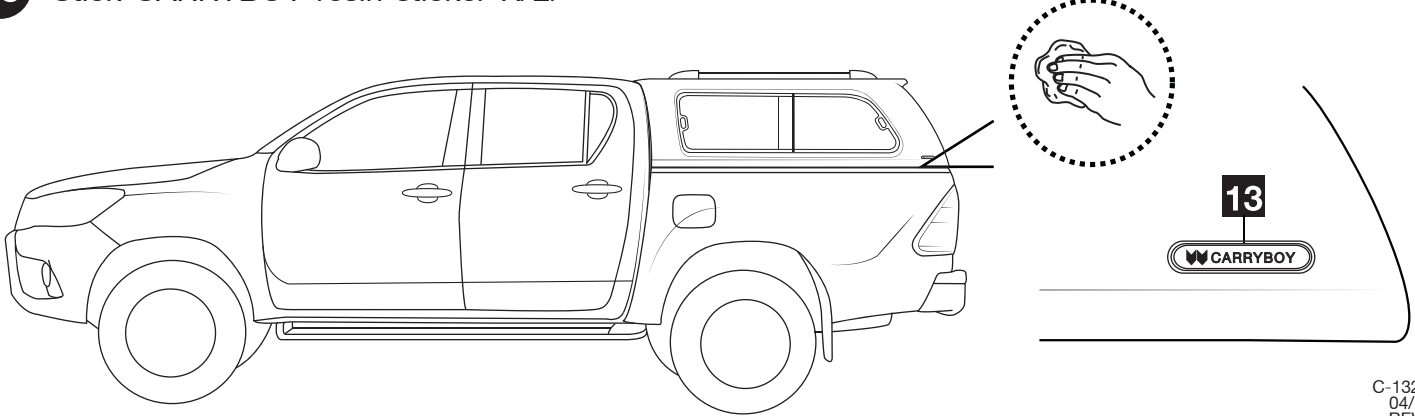

Wiring diagram (Front harness)

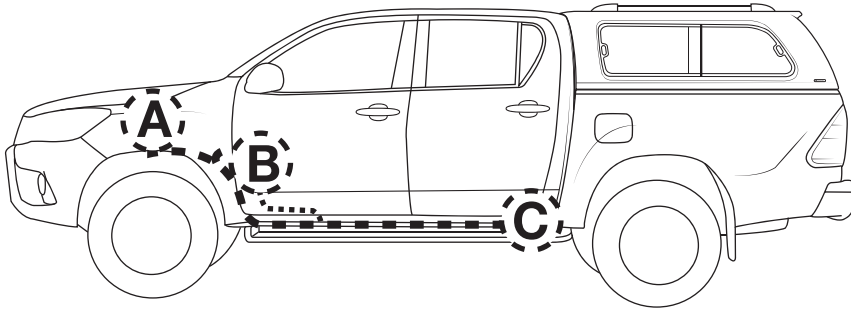

C-090437-02

- Brake
- Remote
- Room Lamp
- Defogger

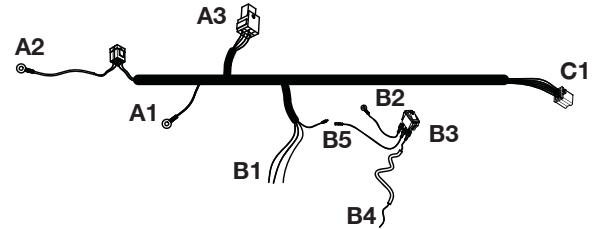

Detail A

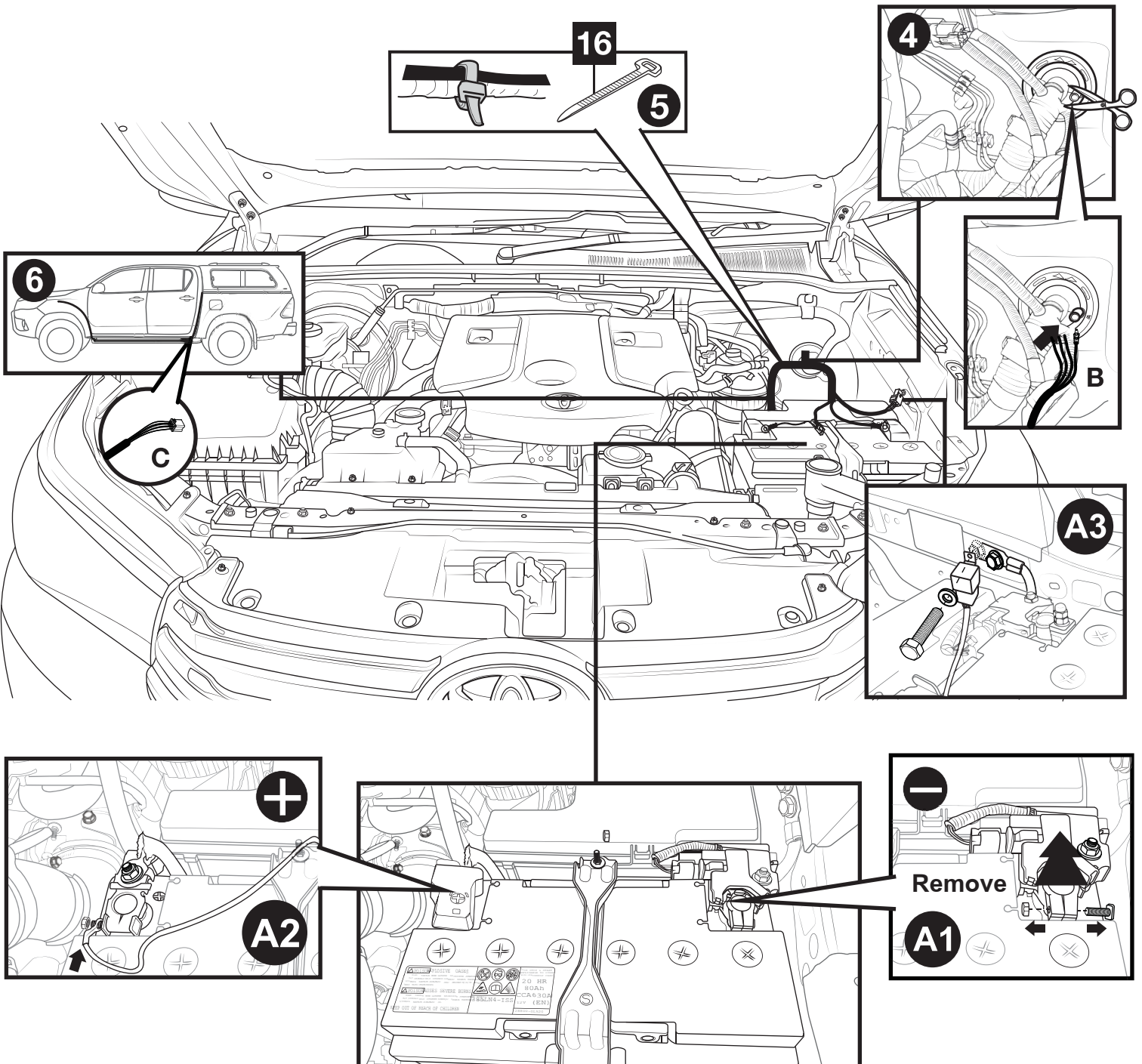

Detail B

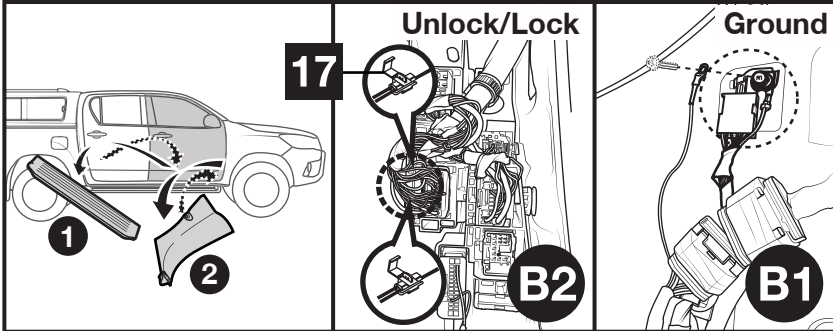
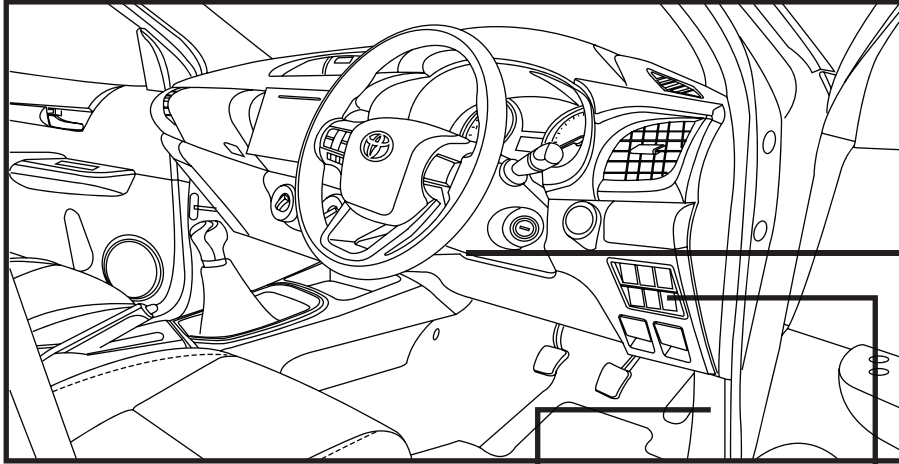

Defogger wiring method.

Remove the front console to install the defogger switch. Insert through the defogger switch from the back to the front console and plug it back properly.

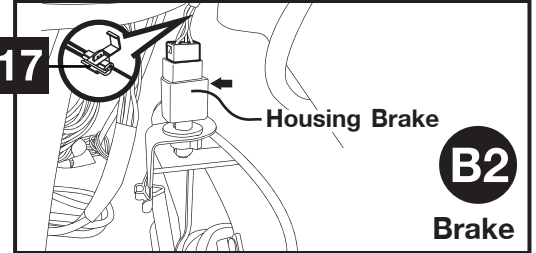
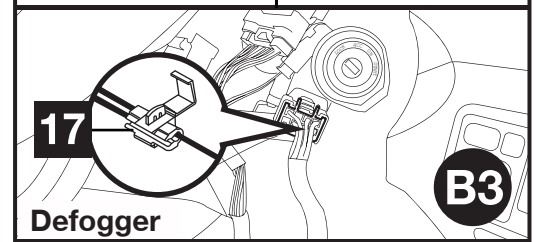
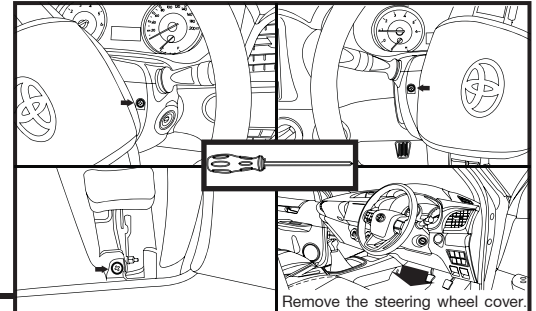
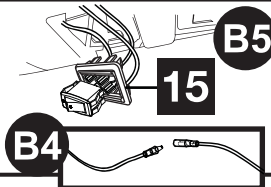

	Car	Wiring harness
Brake	Green-White	Blue
Room Lamp	Battery +	(Ring)
Defogger	Black	White
Lock	White	Green
Unlock	Black	Light blue

Detail C

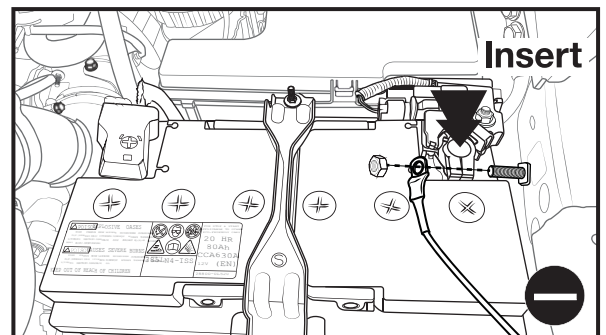
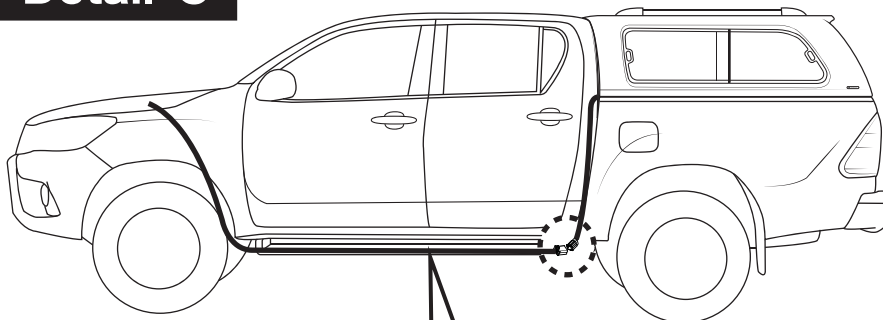

Connection wiring harness to the wiring hardtop.

DETAIL A	
①	Black 1.50 SQMM
②	Red 1.25 SQMM
③	Green 0.5 SQMM
④	Yellow 0.5 SQMM
⑤	Blue 0.5 SQMM
⑥	White 0.5 SQMM

BACK VIEW

Wiring harness

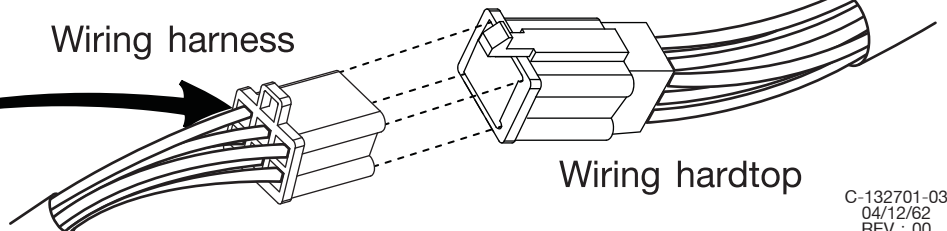

Wiring diagram (Rear harness)

C-090437-06

- Brake
- Remote
- Room Lamp
- Defogger

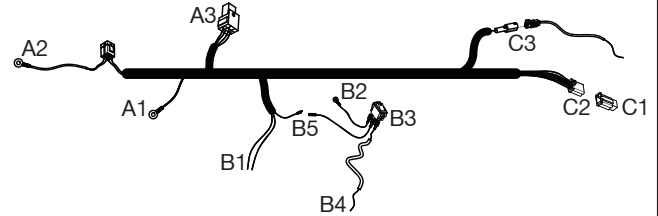
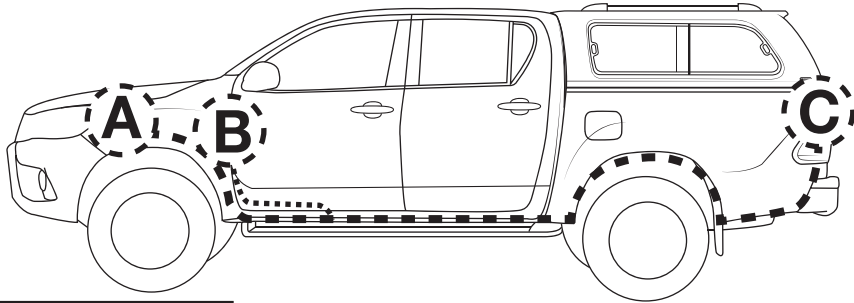

Detail A

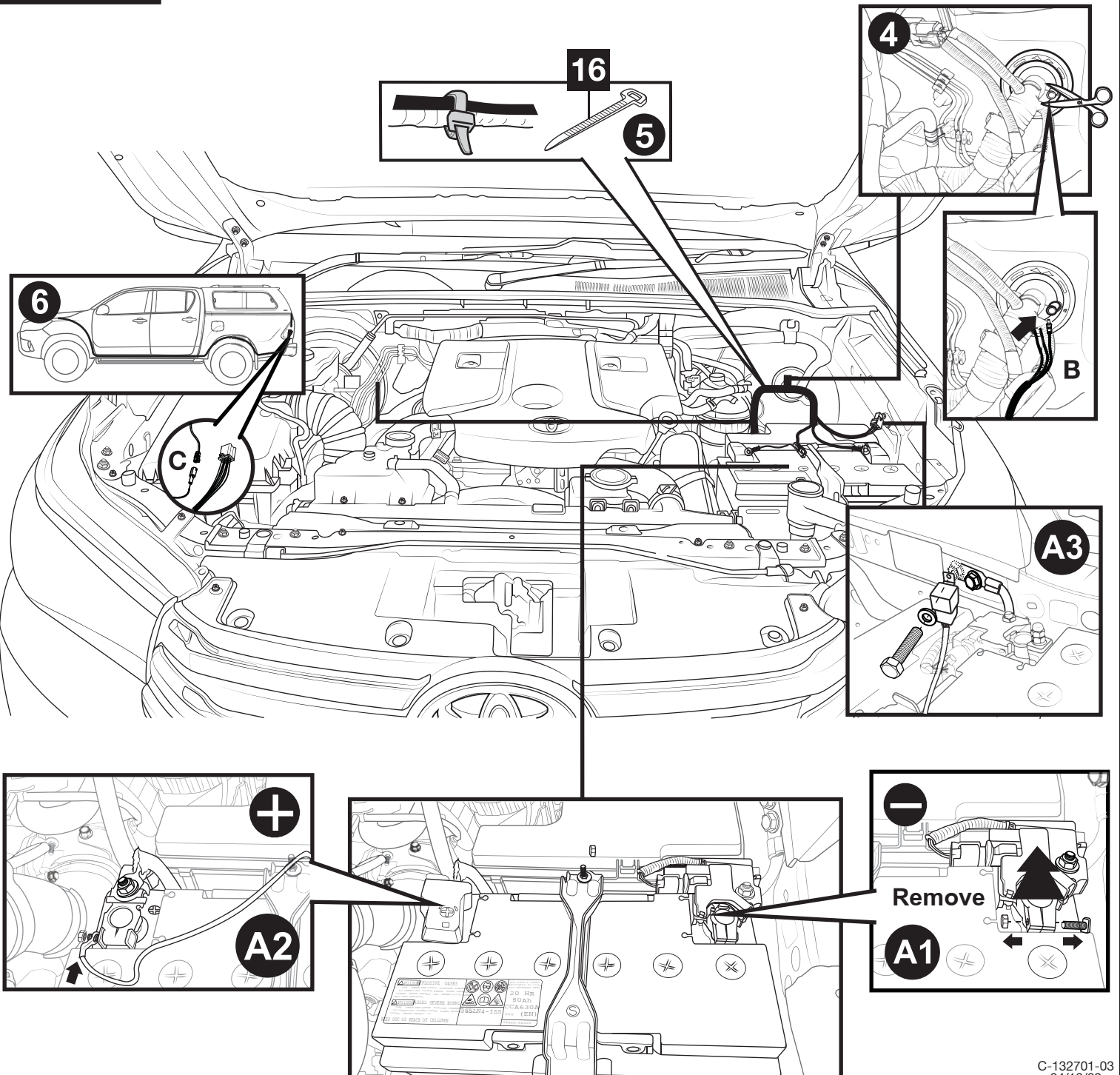

Detail B

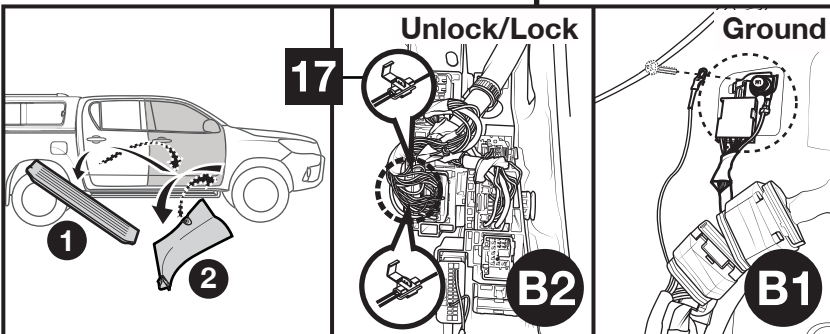
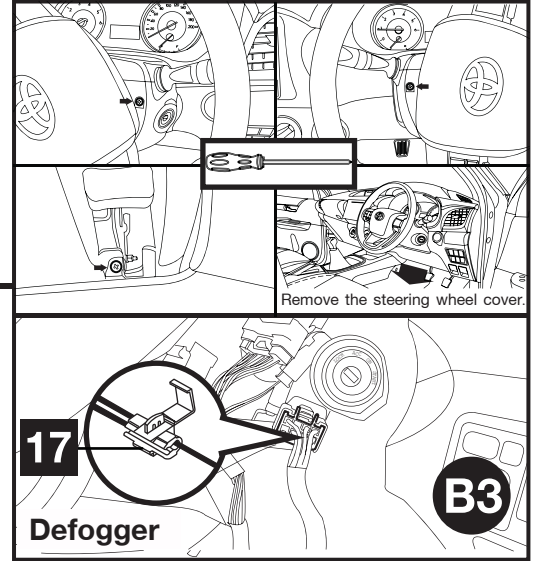
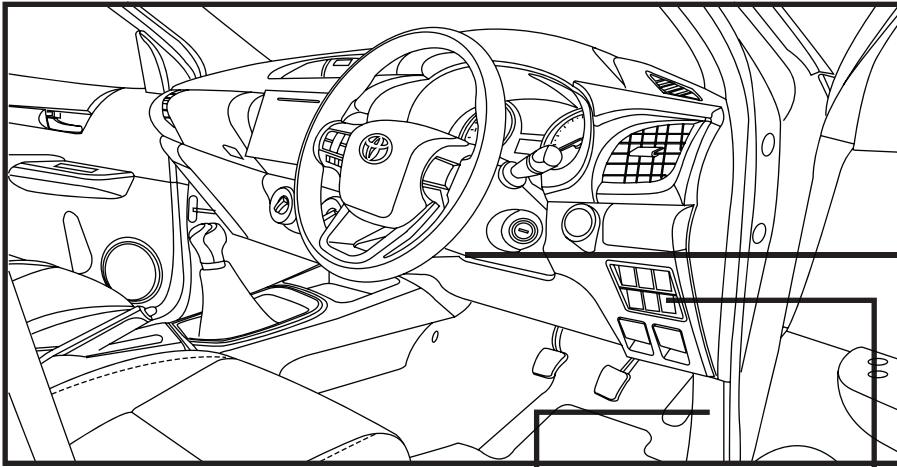

	Car	Wiring harness
Brake	Green-White	Blue
Room Lamp	Battery +	(Ring)
Defogger	Black	White
Lock	White	Green
Unlock	Black	Light blue

Defogger wiring method.

Remove the front console to install the defogger switch. Insert through the defogger switch from the back to the front console and plug it back properly.

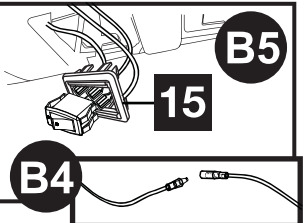

Detail C

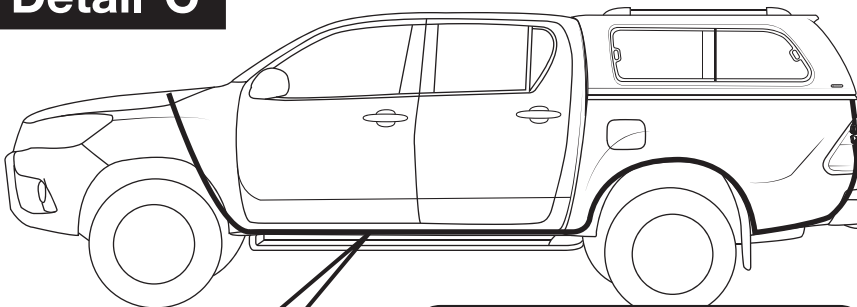

Remove taillamp (RH/LH)

DETAIL A

①	Black	1.50 SQMM
②	Red	1.25 SQMM
③	Green	0.5 SQMM
④	Yellow	0.5 SQMM
⑤	Blue	0.5 SQMM
⑥	White	0.5 SQMM

BACK VIEW

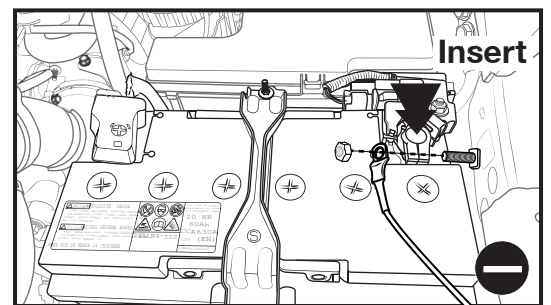

Car electric line

