

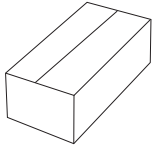









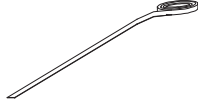

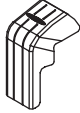
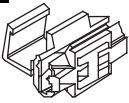

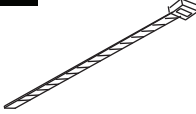
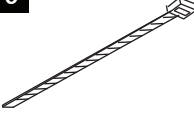
INSTALLATION G3V

PARTS

<p>1</p>  <p>Spare part carton</p>	<p>2</p>  <p>Weatherstrip #205/2</p>	<p>3</p>  <p>Sponge Seal</p>	<p>4</p>  <p>S4 AL. Kwick Klamp</p>	<p>5</p>  <p>Kwick Klamp Cover</p>
<p>6</p>  <p>Electric klamp lock</p>	<p>7</p>  <p>Wiring kit</p>	<p>8</p>  <p>Black Cable Tie</p>	<p>9</p>  <p>White Cable Tie</p>	<p>10</p>  <p>Adaptor Switch</p>
<p>11</p>  <p>JP 8-1/2 EDP Screw</p>	<p>12</p>  <p>2.5m. Double Side Tape</p>	<p>13</p>  <p>Carryboy Resin Plate</p>	<p>14</p>  <p>Bushing</p>	<p>15</p>  <p>Gas Strut Sticker</p>
<p>16</p>  <p>Ball Strut</p>	<p>17</p>  <p>Installation Manual</p>	<p>18</p>  <p>Installation Check List</p>		

A Clean the surface of the truck top edge .

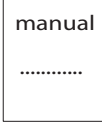
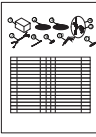
B Place the sponge seal the truck top edge.

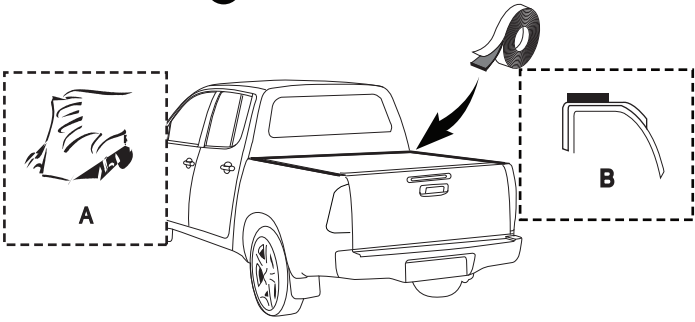

C Put the hardtop on top for the sponge seal and align left and right properly.

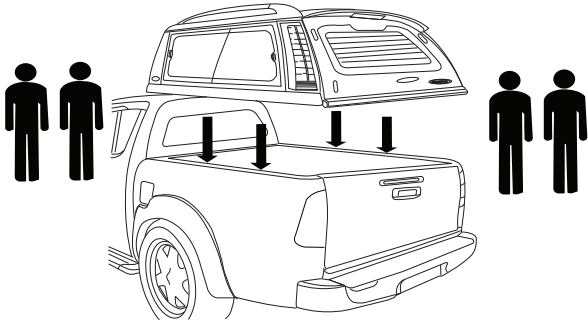

D Install kwick klamp at 6 position points. (DETAIL A and DETAIL B)

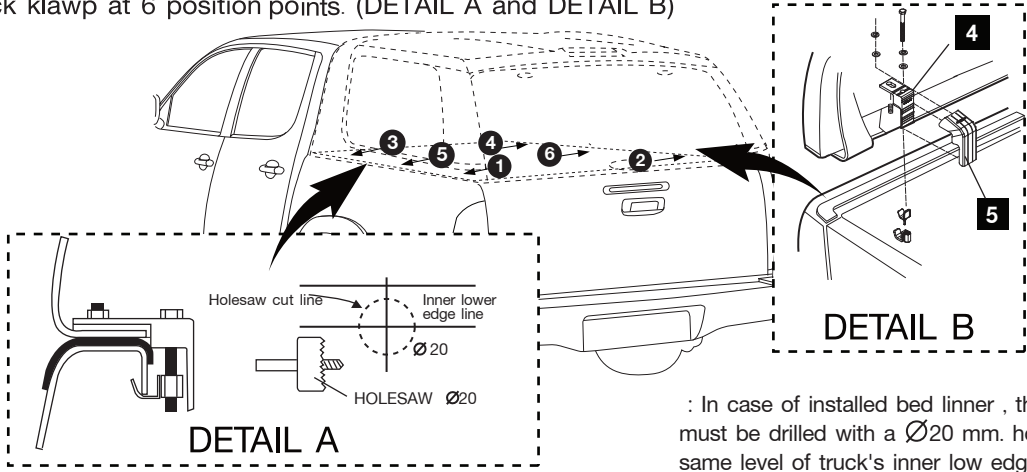

DETAIL A

DETAIL B

: In case of installed bed liner , the bed liner must be drilled with a $\varnothing 20$ mm. holesaw at the same level of truck's inner low edge.

INSTALLATION G3V

E Adjust the position of rear door latches both LH and RH by 13mm. spanner.

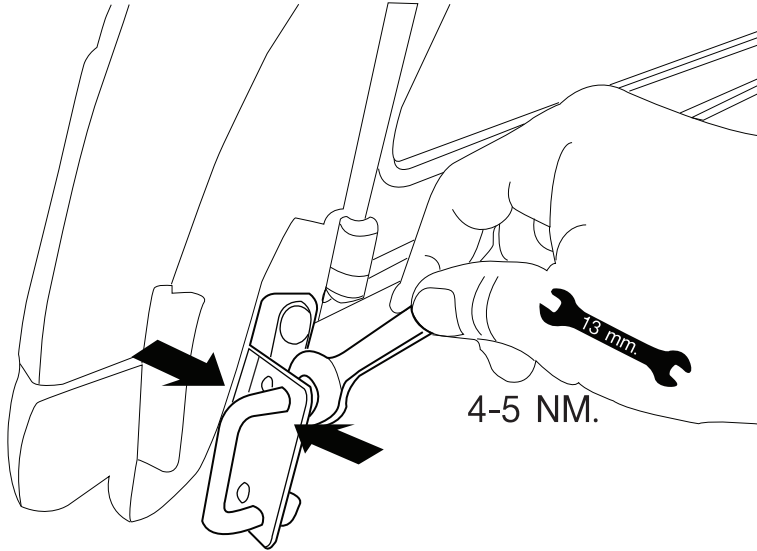

F Align and adjust with 2 steps rotary lock system.

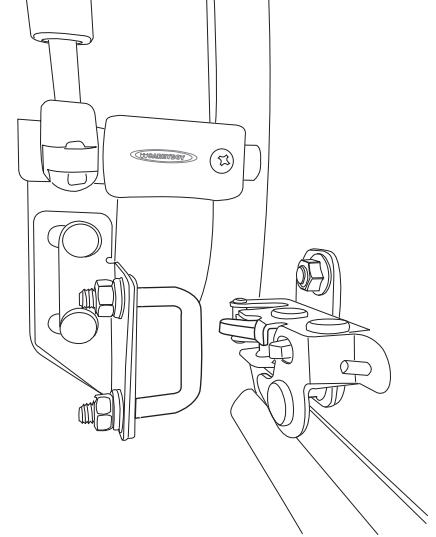

WIRING DIAGRAM

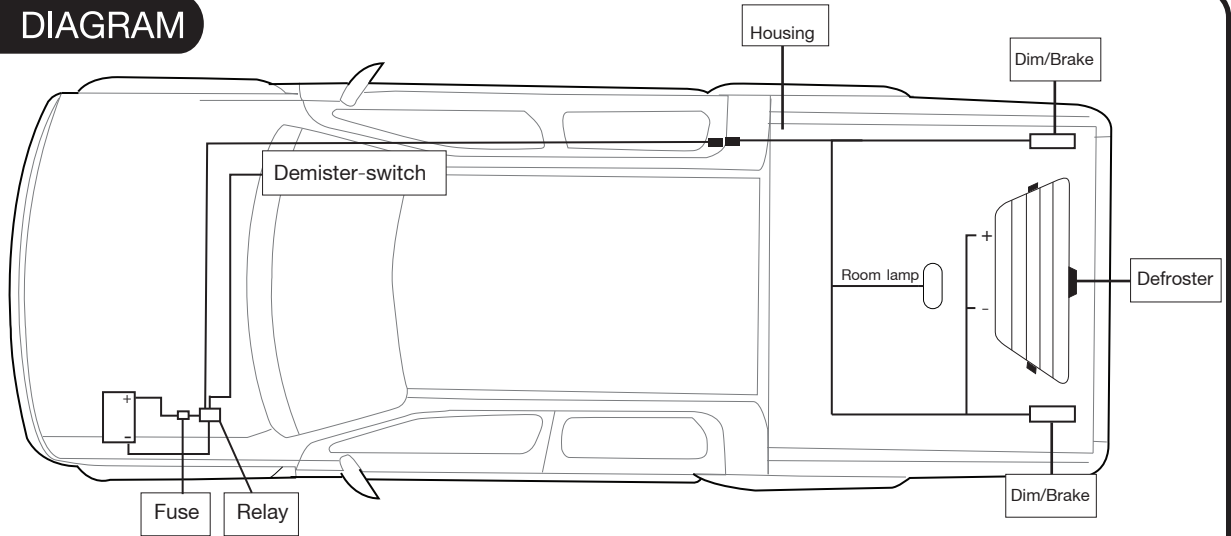

Fuse
15A Demister
5A Roomlamp

G Run the wiring kit and tie up with cable tie provided.

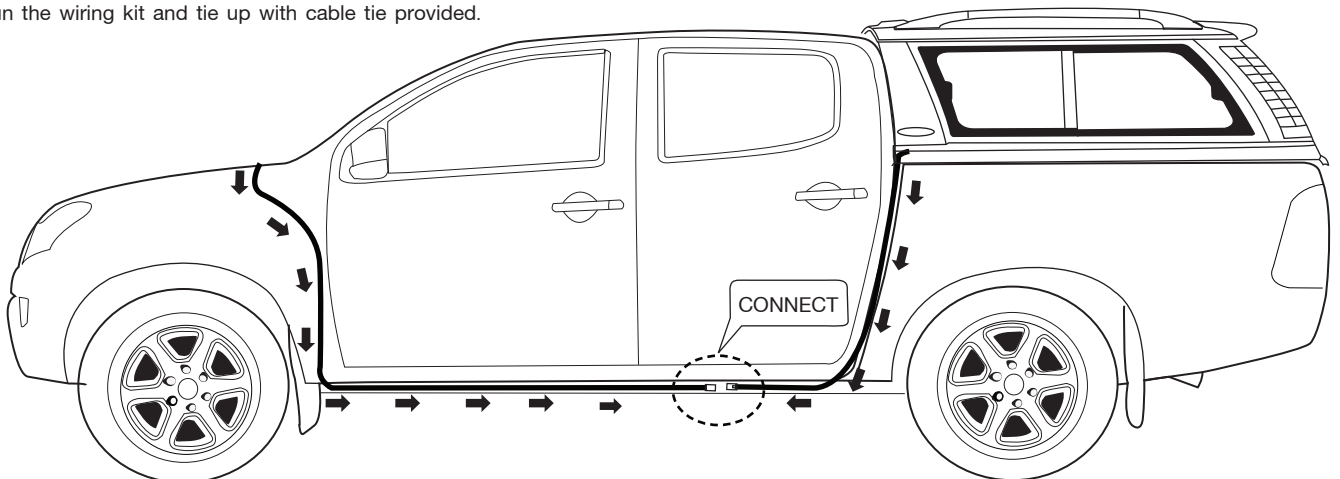

INSTALLATION G3V

Demister Wiring Method

- 1** Remove the front console to install the demister switch.

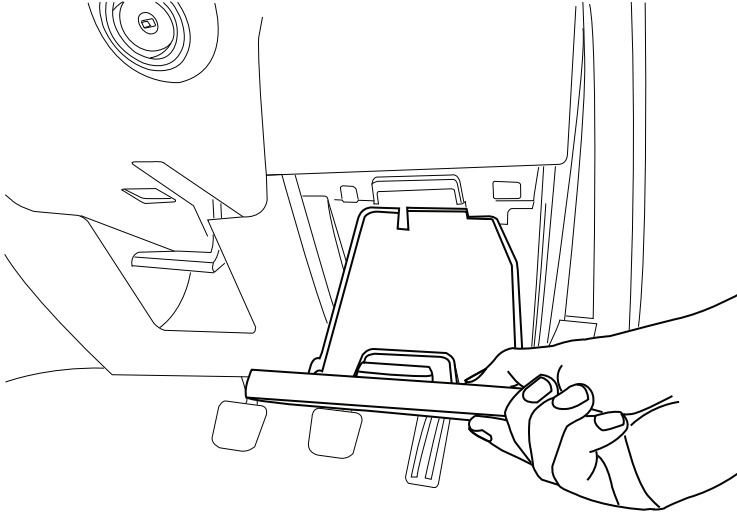

- 2** Remove the boot set both LH and RH.

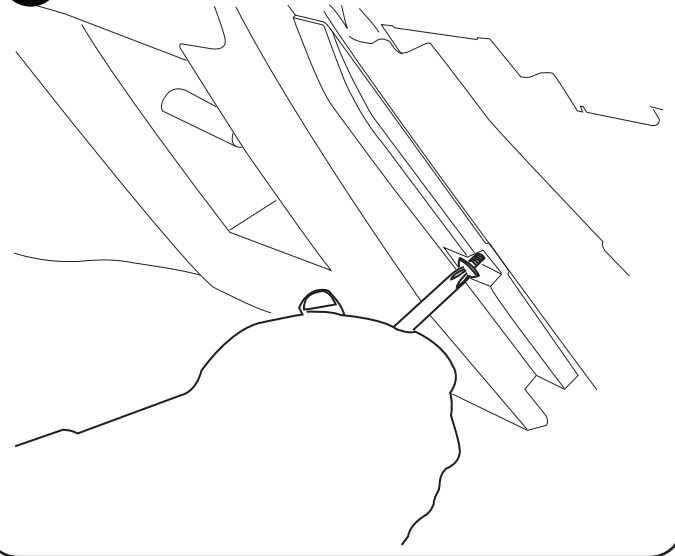

- 3** Insert through the demister switch from the back to the front console and plug it back properly.

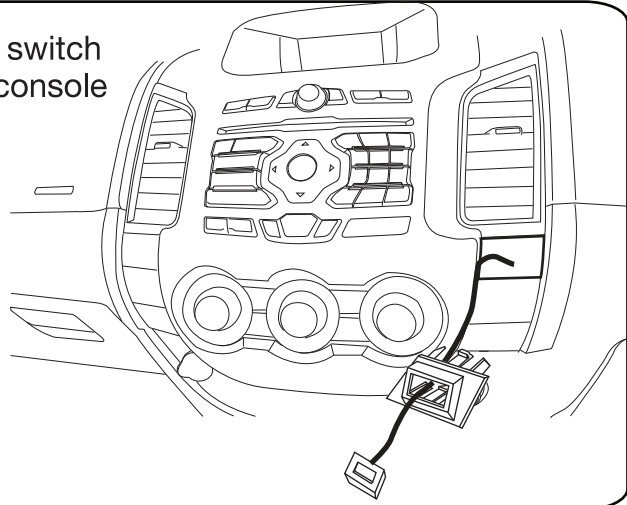

- 4** Run the wiring from the battery through the front bushing hole.

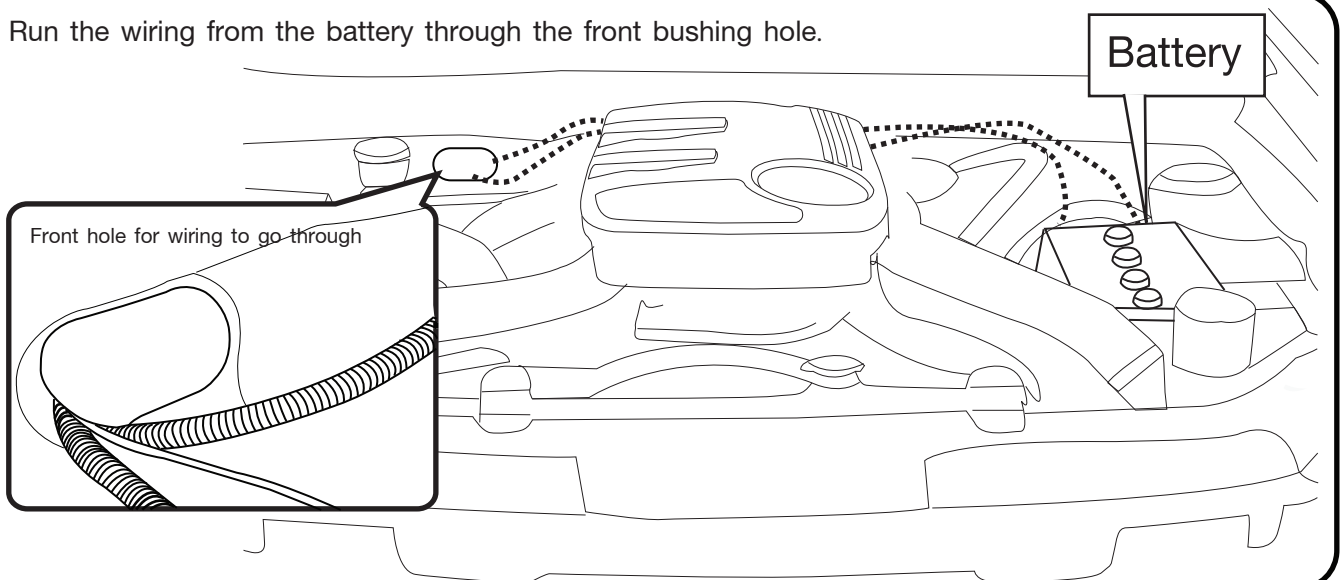

INSTALLATION G3V

- F** Put the gas strut sticker on as per detail A.
Install the weatherstrip over the rain channel edge and put along from RH to LH as per detail B.

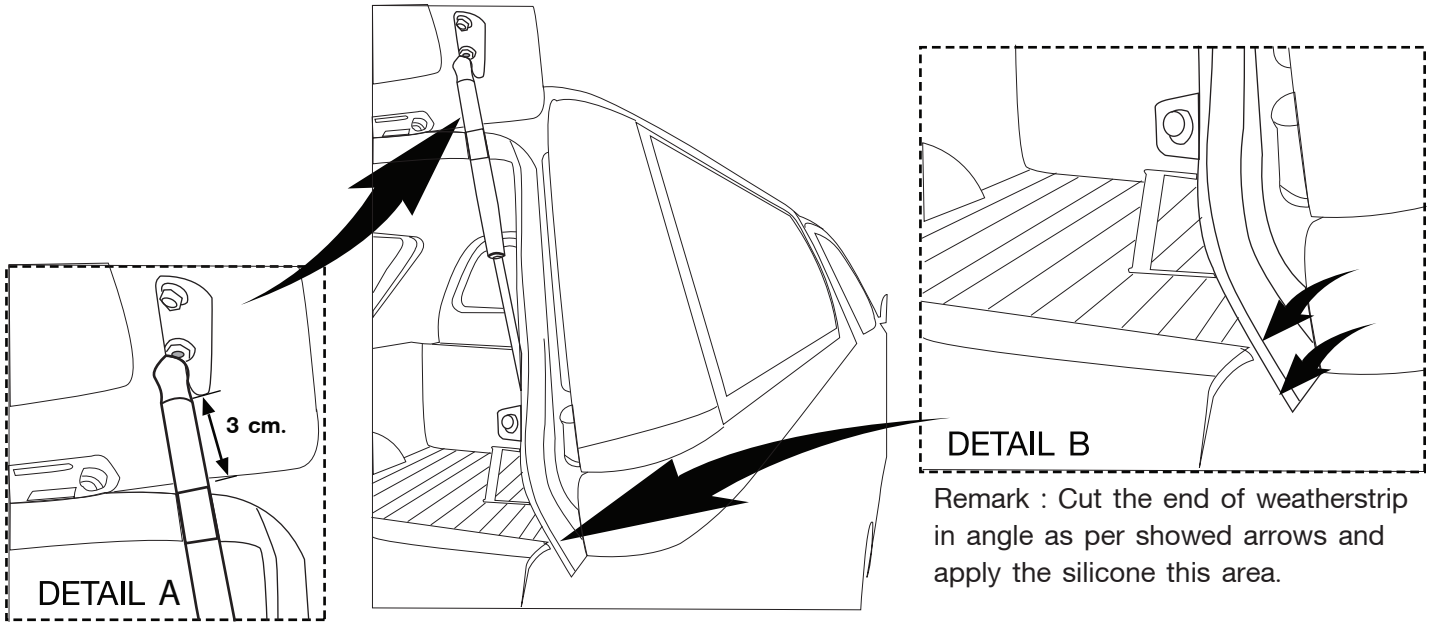

- G** Stick the provided Carryboy resin logo to the same level positions.

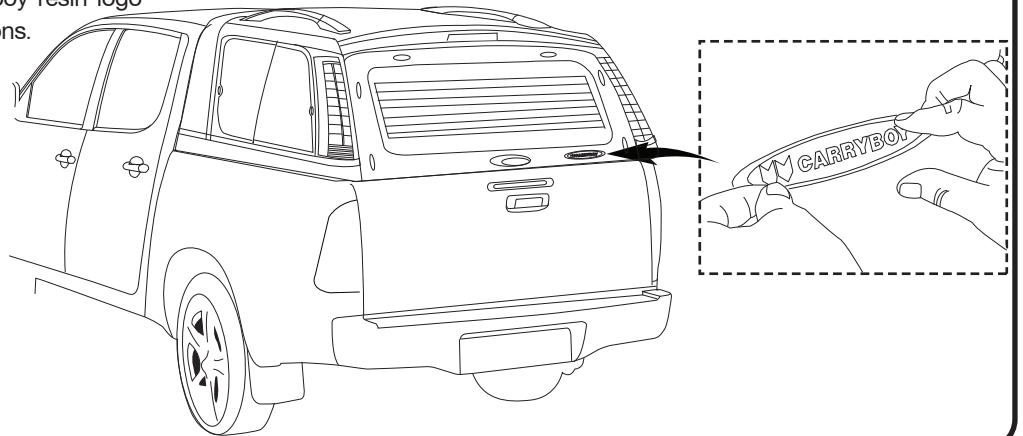

:Recommendation : Adjust and tighten bolts and nuts on the Kwick Klamp every 5,000 kilometers.