

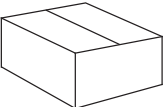











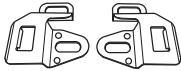



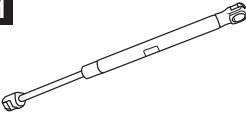
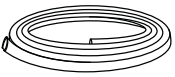



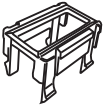
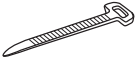

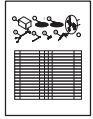
INSTALLATION PARTS

<p>1</p>  <p>Installation kit box 1 pc. C-130043</p>	<p>2</p>  <p>Sponge rubber edge 1 roll. C-020494-04</p>	<p>3</p>  <p>Sponge edge U.S.A 1 roll. C-020050</p>	<p>4</p>  <p>Kwick klamp S6 1 set. C-120490-02</p>	<p>5</p>  <p>Kwick klamp cover 6 pcs. C-100597-01BL</p>
<p>6</p>  <p>Latch STL S-5 R/L 1 pair. C-110060</p>	<p>7</p>  <p>Double bolt M8x33 SUS 2 pcs. C-120108S</p>	<p>8</p>  <p>PVC Double bolt washer 2 pcs. C-020221V</p>	<p>9</p>  <p>Nut M8 SUS 4 pcs. C-030645</p>	<p>10</p>  <p>AL adjustable shim for latch 2 pcs. C-110160</p>
<p>11</p>  <p>Shock STABILUS GAS 2 pcs. C-160204</p>	<p>12</p>  <p>Weather strip 1 roll. C-020132</p>	<p>13</p>  <p>Screw 2 pcs. C-030059</p>	<p>14</p>  <p>CARRYBOY SR5 LOGO 2 pcs. C-160416-01</p>	<p>15</p>  <p>Wiring harness 1 set. C-090437-02(Front) or C-090437-06(Rear)</p>
<p>16</p>  <p>Box switch 1 pc. C-100530</p>	<p>17</p>  <p>Cable tie 5.5" 15 pcs. C-130046</p>	<p>18</p>  <p>Electric klamp lock 4 pcs. C-160259</p>	<p>19</p>  <p>Installation manual 1 set. C-132701-10</p>	<p>20</p>  <p>Check list 1 pc. CL-280045-16</p>
<p>21</p>  <p>Folded steel retaining the rear pick-up edge 1 pc. C-041595-01</p>	<p>22</p>  <p>Folded steel bracket pick-up edge 1 pc. C-171136-02</p>	<p>23</p>  <p>Bolt M6x10 SUS304 EDP 4 pcs. C-030452B</p>	<p>24</p>  <p>Washer M5 PVC 4 pcs. C-030583</p>	

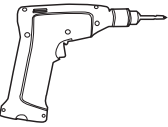
INSTALLATION TOOLS

<p>1</p>  <p>Screw Driver</p>	<p>2</p>  <p>Torque Wrench No.13</p>	<p>3</p>  <p>Wrench No.13</p>	<p>4</p>  <p>Cutter</p>	<p>5</p>  <p>Measuring tape</p>
---	--	---	---	---

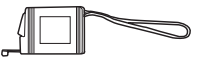
1 Assembling the bracket and aluminum rail for tailgate end caps.

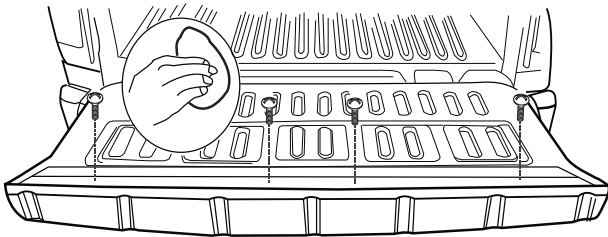

Cleaning and removing the bolts of the vehicle as shown.

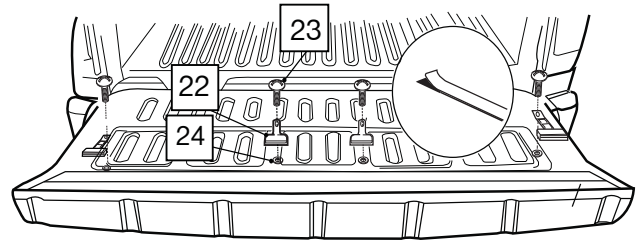

Assembling the bracket rail for tailgate.

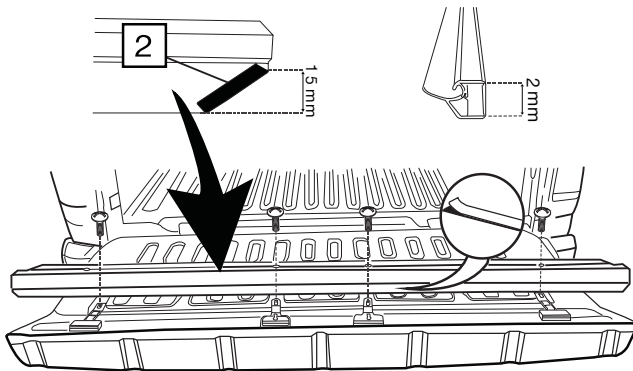

Stick the sponge stick to the edge of the U.S.A. area on the L/R side and Assemble the AL end cap by arranging AL. the end cap is between Mid-tailgate.

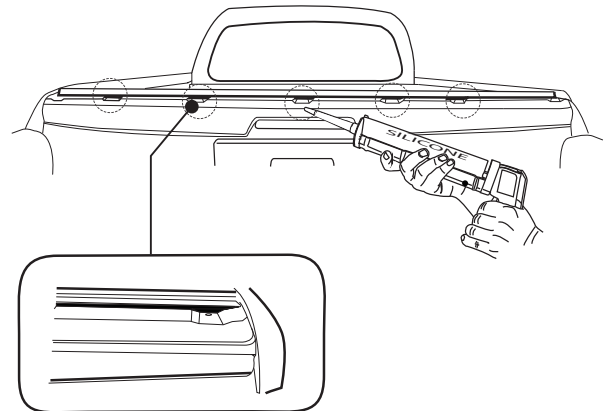

Perform silicon at the top of the spoiler and the sides L/R.

2 Clean the edge of truck bed.

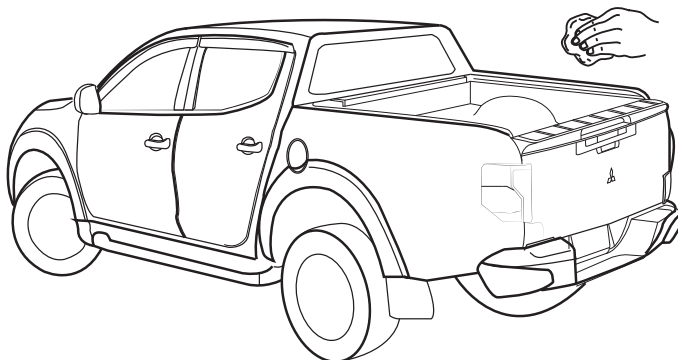

3 Install rubber truck edge under the hardtop.

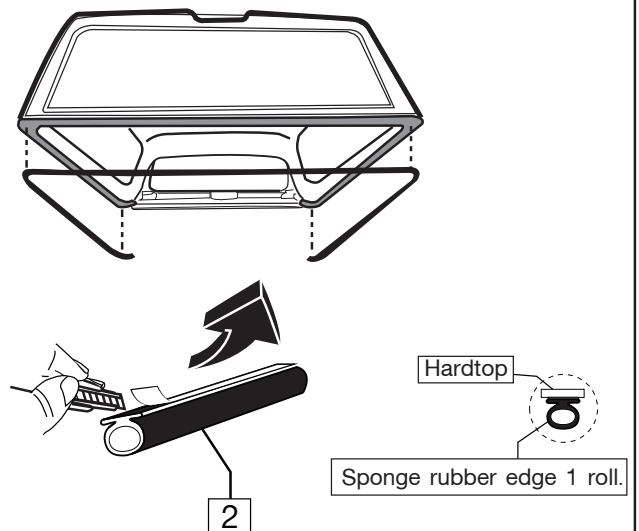

4 Place hardtop on the truck bed and adjust alignment between left and right.

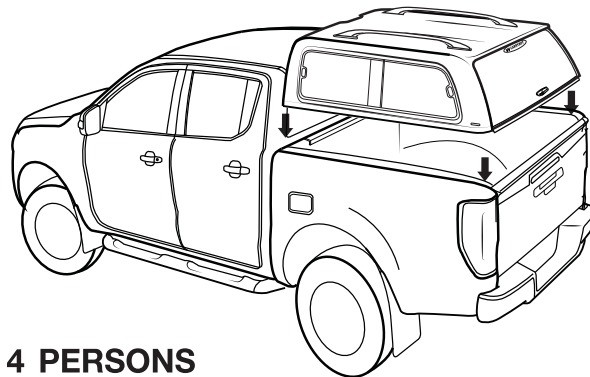

4 PERSONS

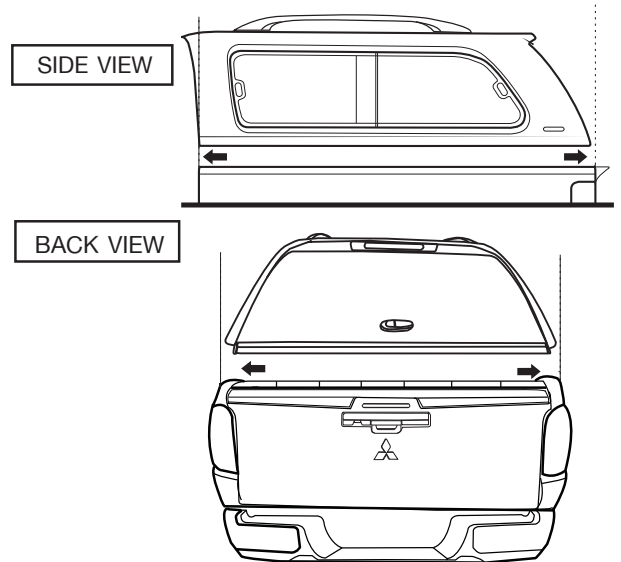

5 Install quick klamp for 6 positions.

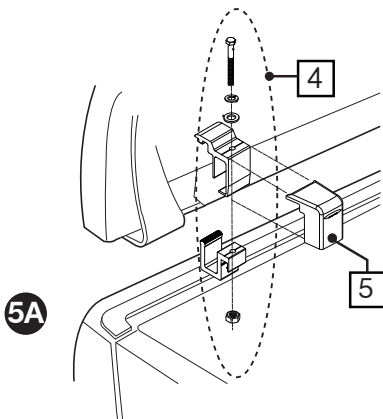
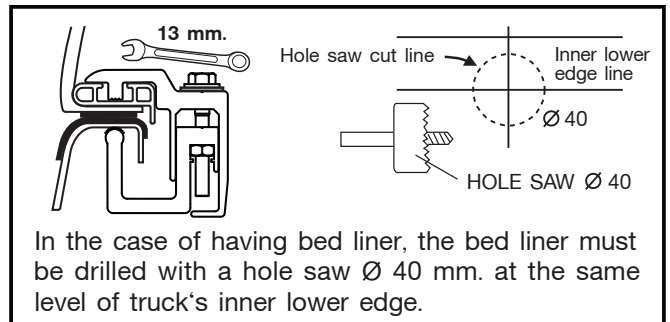
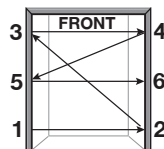
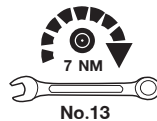
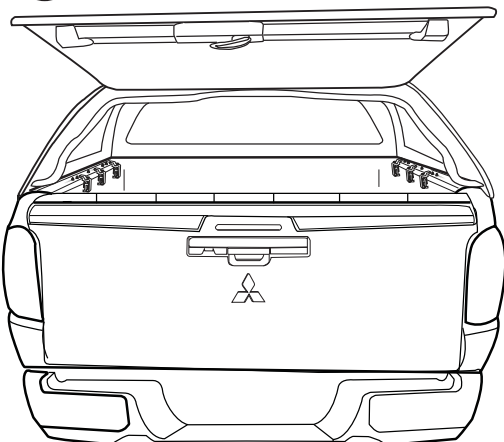

Put the lower Al. klamp through the bolt M8x70 follow the diagram. Then, tighten the lower Al. klamp with truck's inner lower edge and bolt M8x70.

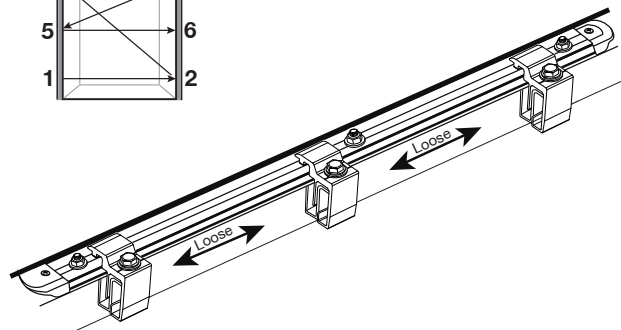

5B Remove the nut's spring washer and washer from 3 loose bolts. Then, put the upper Al. clomp klamp on the Al. rail through the hole on the top of upper Al. klamp. Tighter nuts, spring washer and washer back to its original position to lock the upper Al.klamp.

5 Installing Latch on the rear door.

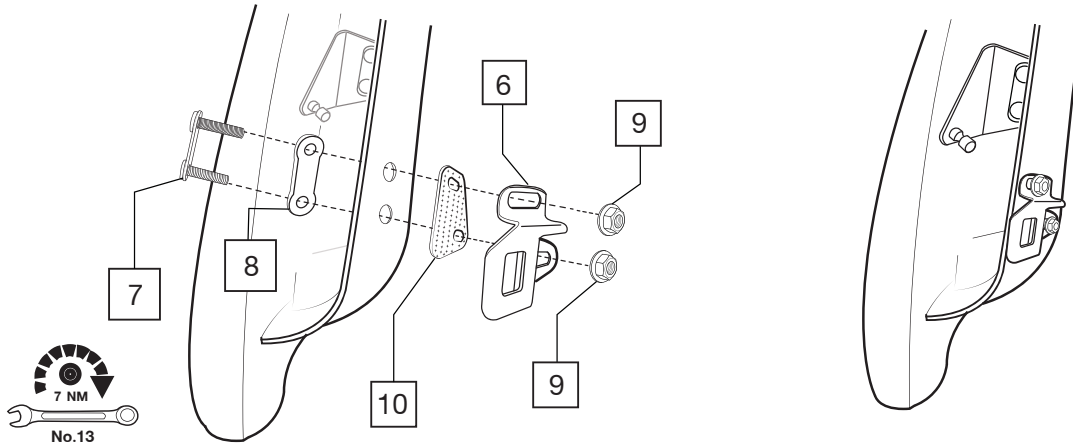

6 Adjust a latch R/L for matching with the slam lock on the rear door.

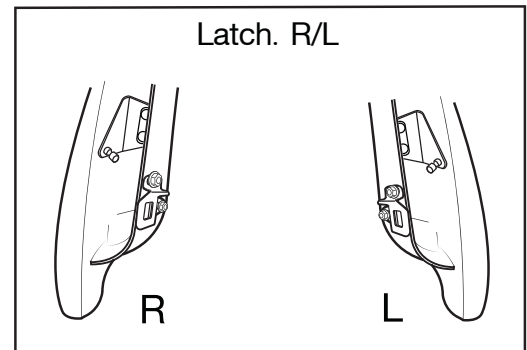
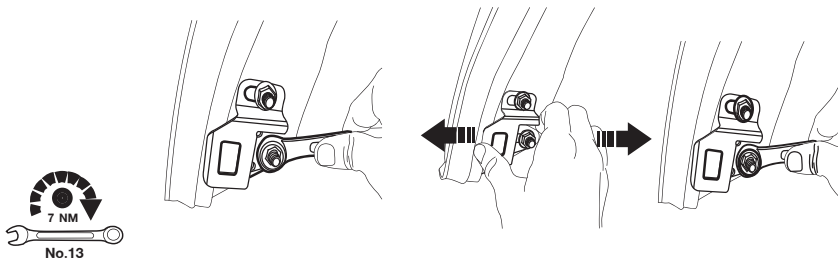

7 Shock absorber assembly.

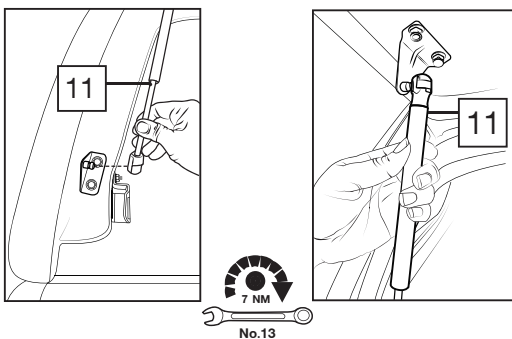

8 Final check the appearance. Glue the silicone to protect water leaking left-right.

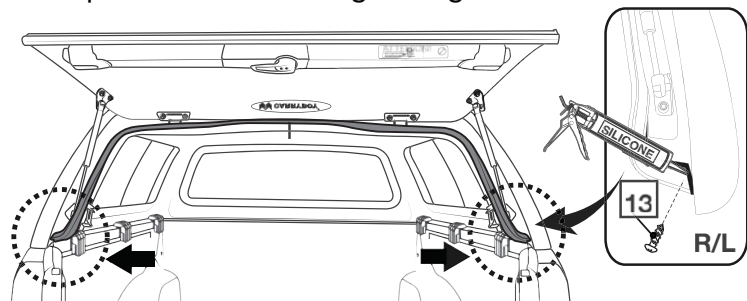

9 Stick CARRYBOY resin sticker R/L.

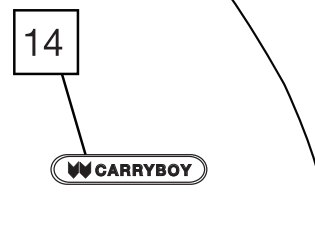
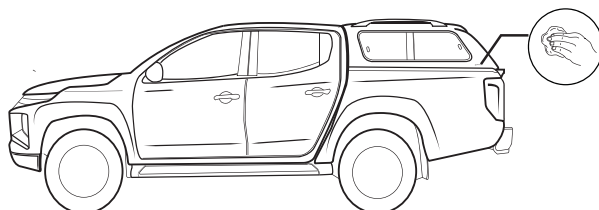

Wiring diagram (Front harness)

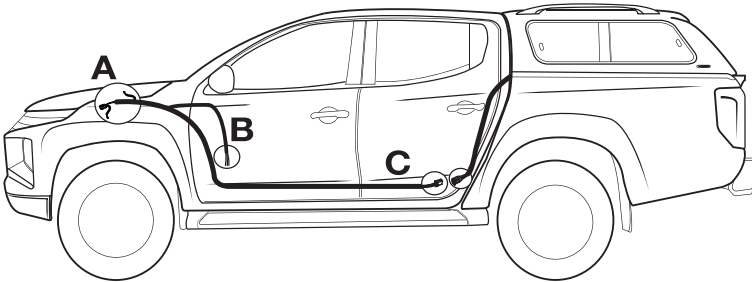

C-090437-02

- Brake
- Room Lamp
- Remote
- Defogger

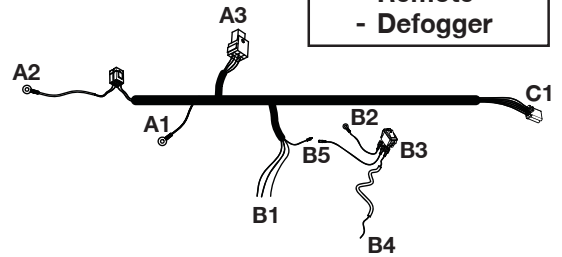

Detail A

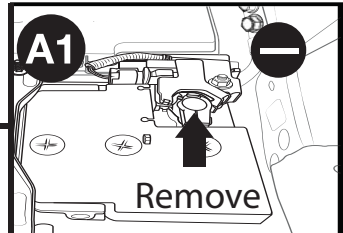
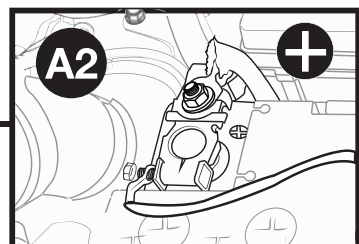
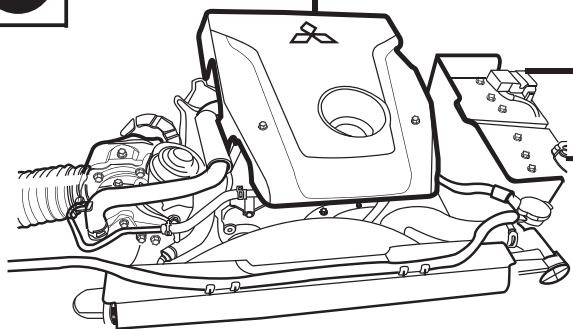
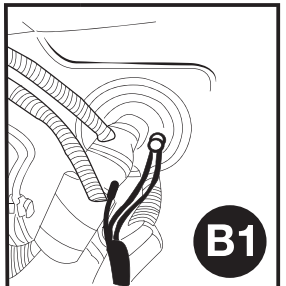
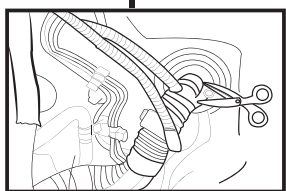
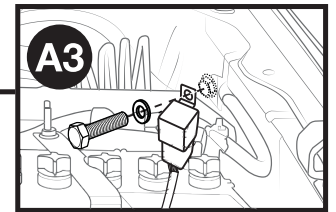
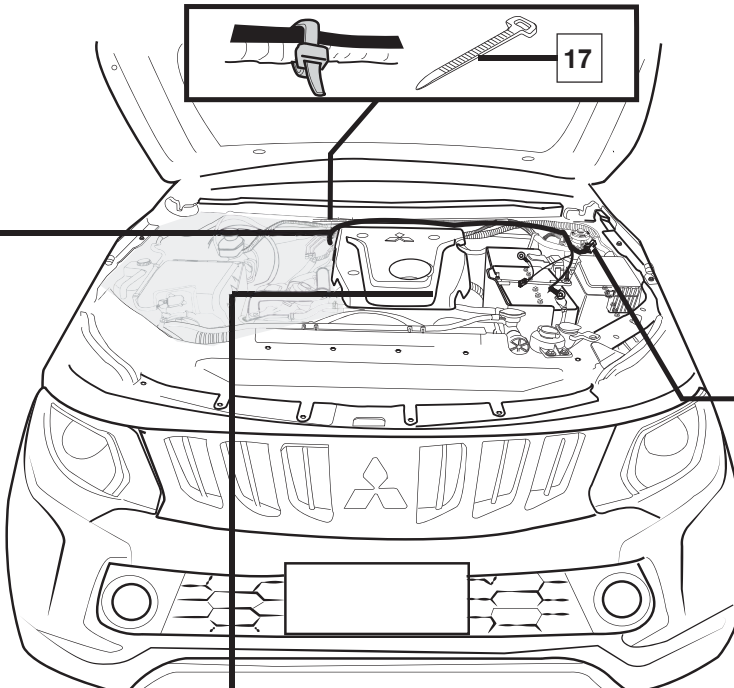
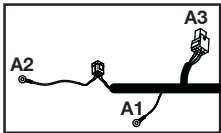

Detail B

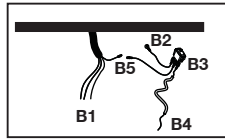

Remove the steering wheel cover

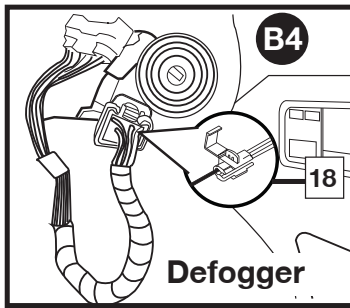

Defogger

Defogger Wiring Method

Remove the front console install the Defogger Switch. Insert through the Defogger Switch from the back to the front console and plug it back properly.

SWITCH ON-OFF HEATER

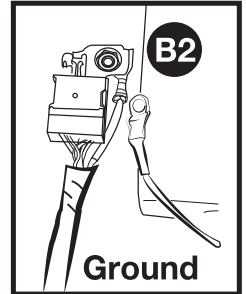

Ground

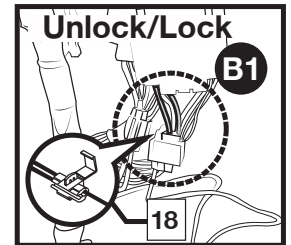
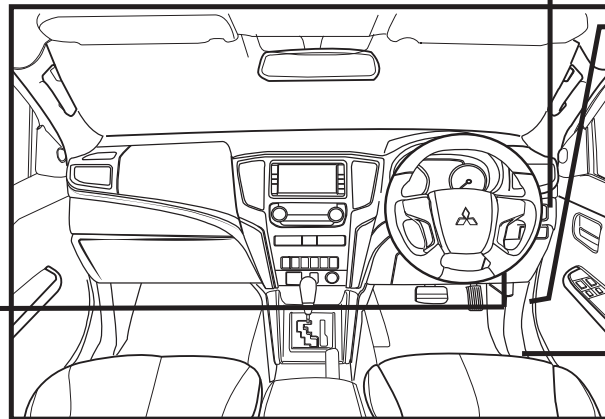

Unlock/Lock

B1

18

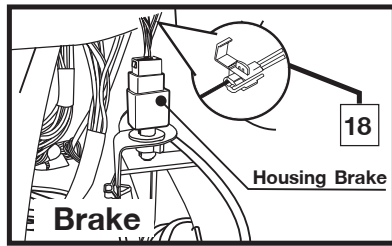

Brake

Housing Brake

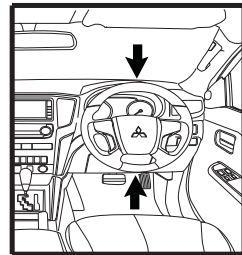

Put on the steering wheel cover

	Car	wiring harness
Defogger	Black	Red
Brake	yellow- Green	Blue
Unlock	Blue - Red	yellow
Lock	Blue - Black	Green
Room Lamp	Battery +	White

Detail C

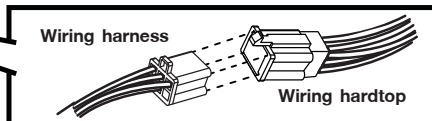
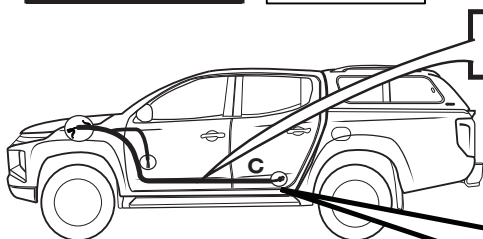

Wiring harness

Wiring hardtop

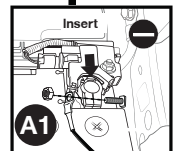
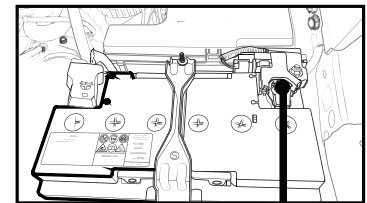

A1

DETAIL A

①	Black 1.50 SQMM
②	Red 1.25 SQMM
③	Green 0.5 SQMM
④	Yellow 0.5 SQMM
⑤	Blue 0.5 SQMM
⑥	White 0.5 SQMM

BACK VIEW

Important



Secure the Canopy Harness to the existing vehicle harness using the supplied cable ties at even intervals ensuring that all harnesses are away from moving parts.

Wiring diagram (Rear harness)

C-090437-06

- Brake
- Room Lamp
- Remote
- Defogger

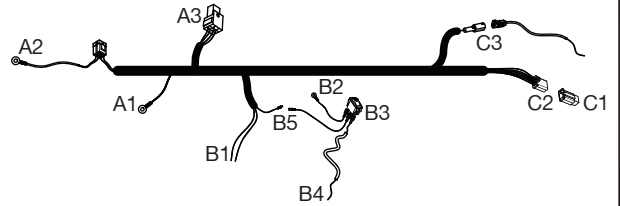
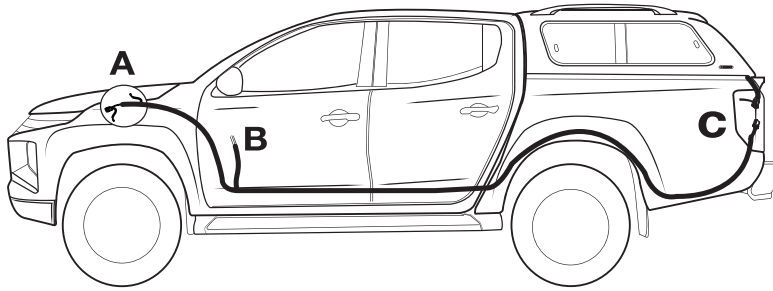

Detail A

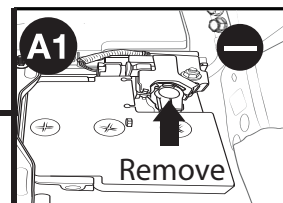
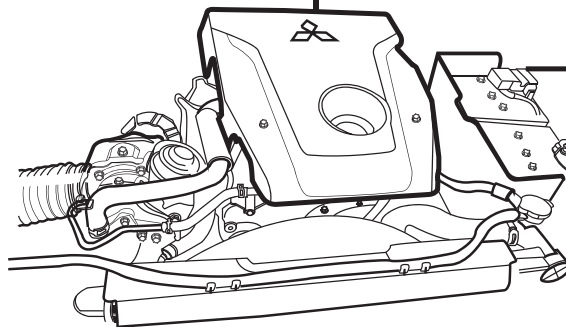
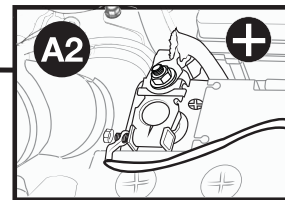
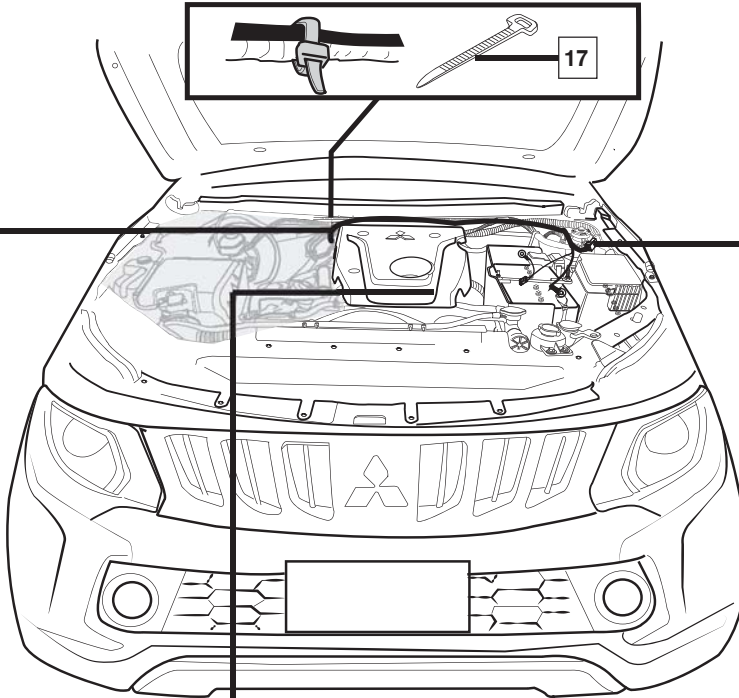
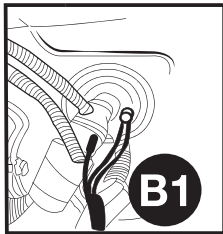
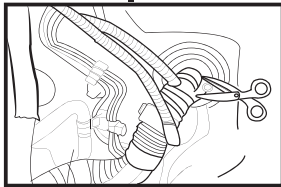
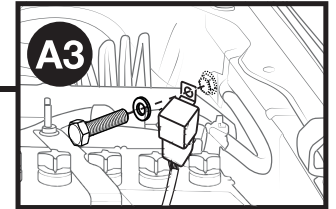
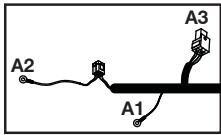

Detail B

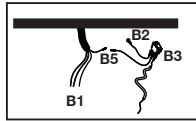

Defogger Wiring Method

B3

Remove the front console install the Defogger Switch. Insert through the Defogger Switch from the back to the front console and plug it back properly.

B5

16

SWITCH ON-OFF HEATER

B2

Ground

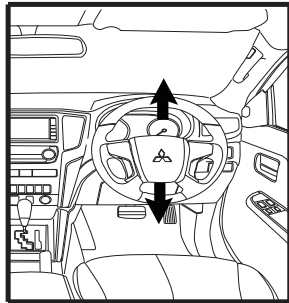

Remove the steering wheel cover

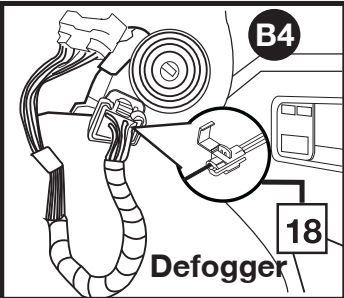

B4

18

Defogger

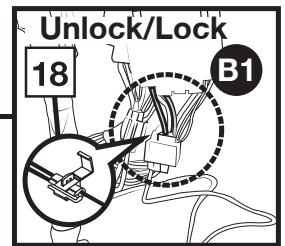
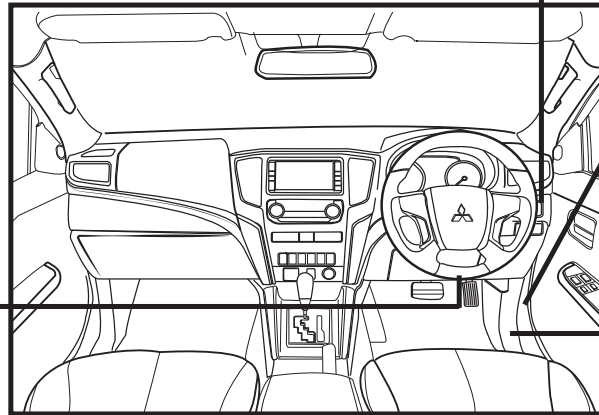

Unlock/Lock

18

B1

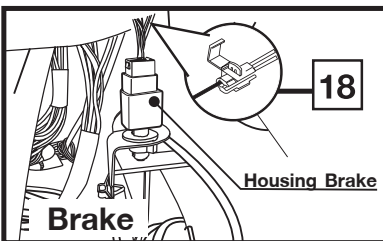

18

Housing Brake

Brake

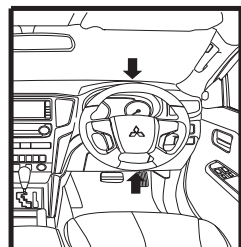

Put on the steering wheel cover

	Car	wiring harness
Defogger	Black	Red
Brake	yellow – Green	Blue
Unlock	Blue – Red	yellow
Lock	Blue – Black	Green
Room Lamp	Battery +	White

Detail C

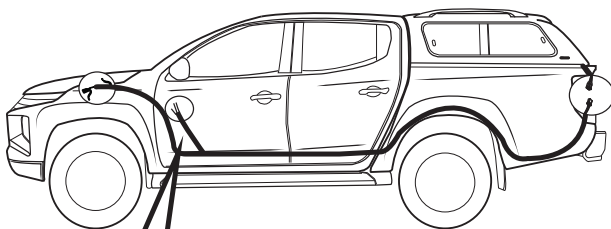
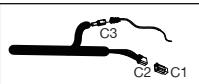

17

- DETAIL A**
- ① Black 1.50 SQMM
 - ② Red 1.25 SQMM
 - ③ Green 0.5 SQMM
 - ④ Yellow 0.5 SQMM
 - ⑤ Blue 0.5 SQMM
 - ⑥ White 0.5 SQMM
- BACK VIEW

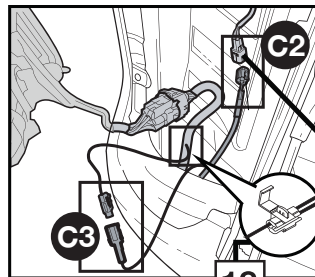

C3

C2

18

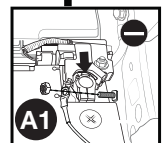
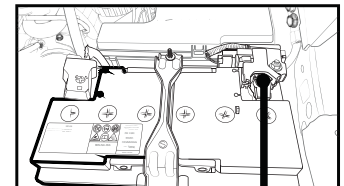

A1

Car electric line

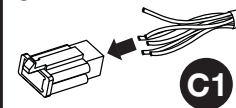

C1