

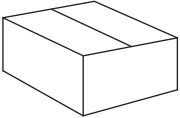









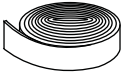

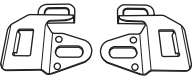



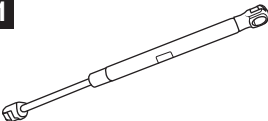
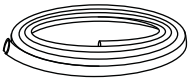

### INSTALLATION PARTS

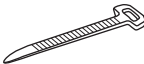
<p><b>1</b></p>  <p>Installation kit box 1 pc. C-130043</p>	<p><b>2</b></p>  <p>Sponge rubber edge 1 roll. C-020494-04</p>	<p><b>3</b></p>  <p>Tape page 2 1 roll. C-070050-01</p>	<p><b>4</b></p>  <p>Kwick klamp S6 1 set. C-120490-02</p>	<p><b>5</b></p>  <p>Kwick klamp cover 6 pcs. C-100597-01BL</p>
<p><b>6</b></p>  <p>Latch STL S-5 R/L 1 pair. C-110060</p>	<p><b>7</b></p>  <p>Double bolt M8x33 SUS 2 pcs. C-120108S</p>	<p><b>8</b></p>  <p>PVC Double bolt washer 2 pcs. C-020221V</p>	<p><b>9</b></p>  <p>Nut M8 SUS 4 pcs. C-030645</p>	<p><b>10</b></p>  <p>AL adjustable shim for latch 2 pcs. C-110160</p>
<p><b>11</b></p>  <p>Shock STABILUS GAS 2 pcs. C-160204</p>	<p><b>12</b></p>  <p>Weather strip 1 roll. C-020132</p>	<p><b>13</b></p>  <p>Screw 2 pcs. C-030059</p>	<p><b>14</b></p>  <p>CARRYBOY SR5 LOGO 2 pcs. C-160416-01</p>	<p><b>15</b></p>  <p>Wiring harness 1 set. C-090432-02(Front) or C-090437-06(Rear)</p>
<p><b>16</b></p>  <p>Box switch 1 pcs. C-100530</p>	<p><b>17</b></p>  <p>Cable tie 5.5" 15 pcs. C-130046</p>	<p><b>18</b></p>  <p>Electric klamp lock 4 pcs. C-160259</p>	<p><b>19</b></p>  <p>Installation manual 1 set. C-132701-01</p>	<p><b>20</b></p>  <p>Check list 1 pc. CL-280045-02</p>

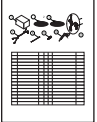
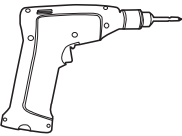
### INSTALLATION TOOLS

<p><b>1</b></p>  <p>Screw Driver</p>	<p><b>2</b></p>  <p>Torque Wrench No.13</p>	<p><b>3</b></p>  <p>Wrench No.13</p>	<p><b>4</b></p>  <p>Cutter</p>	<p><b>5</b></p>  <p>Measuring tape</p>
---	--	---	---	---

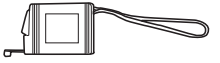
**1** Clean the edge of truck bed.

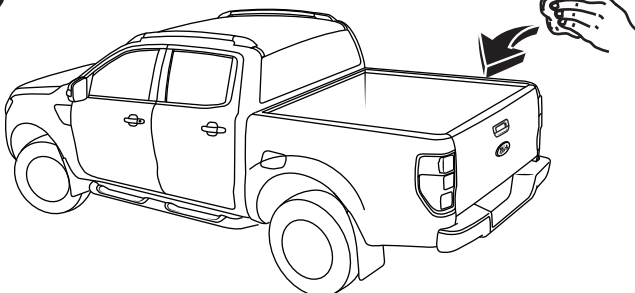

**2** Clean of under the hardtop.

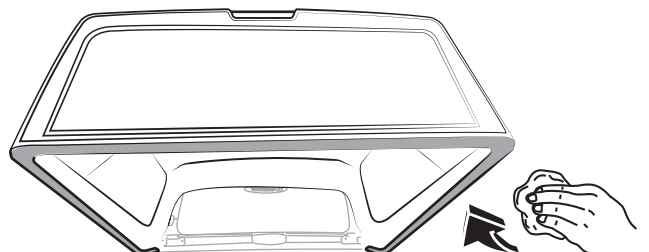

**3** Install rubber truck edge under the hardtop.

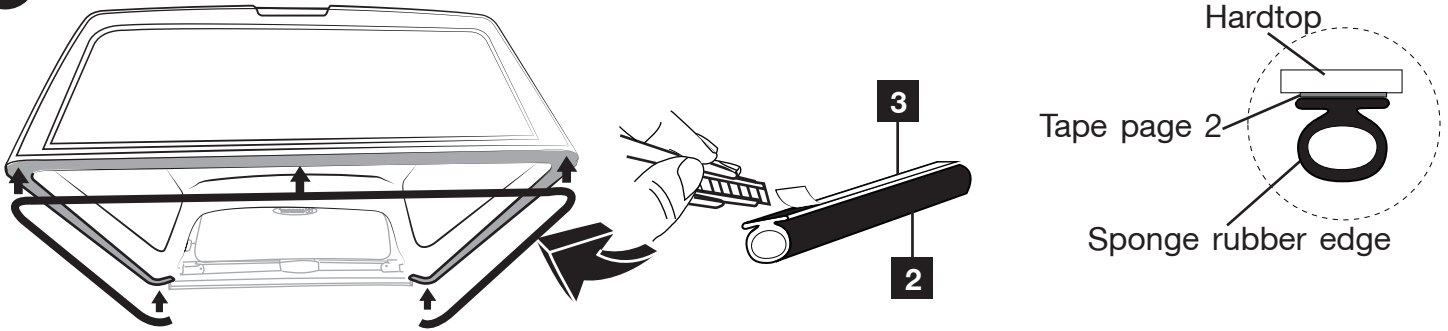

**4** Place hardtop on the truck bed and adjust alignment between left and right.

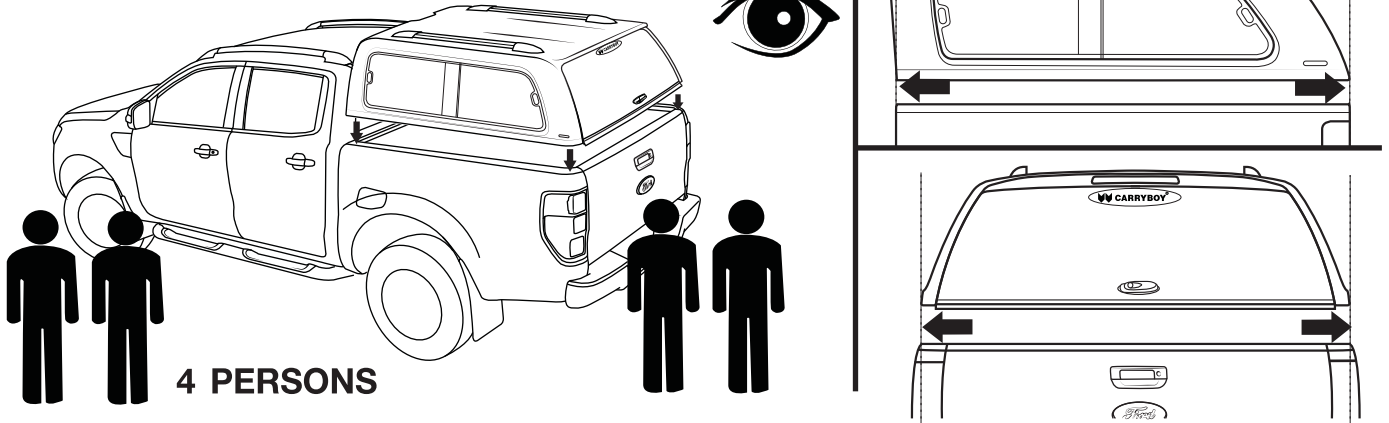

**5** Install kwick klamp for 6 positions.

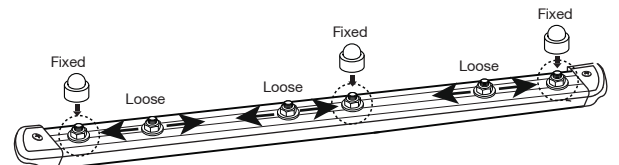
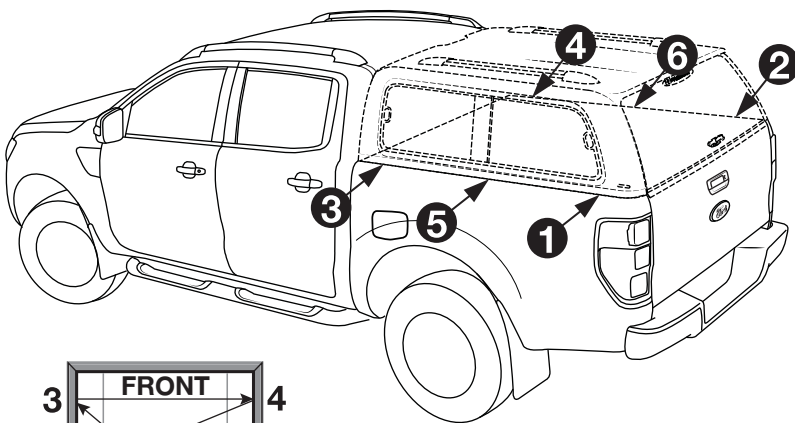

**5A** Adjust the position to fix loose bolts on the Al. rail. (Remarks : In case of having bed liner, Al. Klamp must be fixed at the flat area of the bed liner)

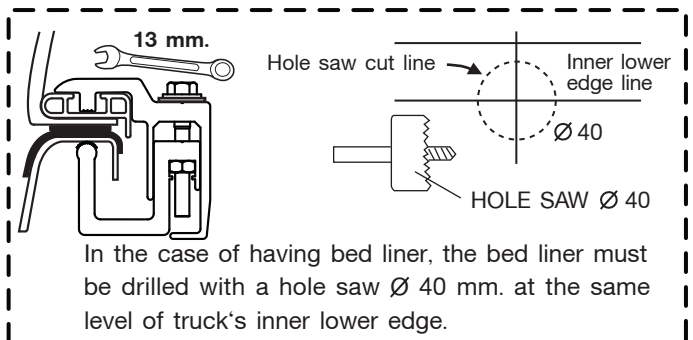

In the case of having bed liner, the bed liner must be drilled with a hole saw Ø 40 mm. at the same level of truck's inner lower edge.

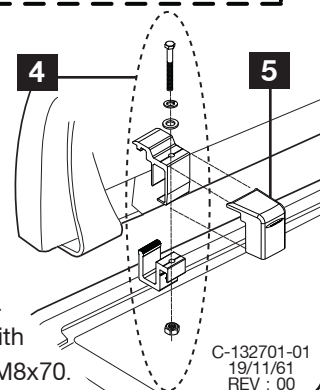
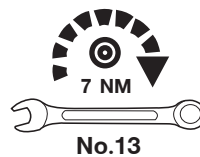

**5B** Remove the nut's spring washer and washer from 3 loose bolts. Then, put the upper Al. clomp klamp on the Al. rail through the hole on the top of upper Al. klamp. Tighter nuts, spring washer and washer back to its original position to lock the upper Al.klump.

**5C** Put the lower Al. klamp through the bolt M8x70 follow the diagram. Then, tighten the lower Al. klamp with truck's inner lower edge and bolt M8x70.

### 6 Installing latch R/L on the rear door.

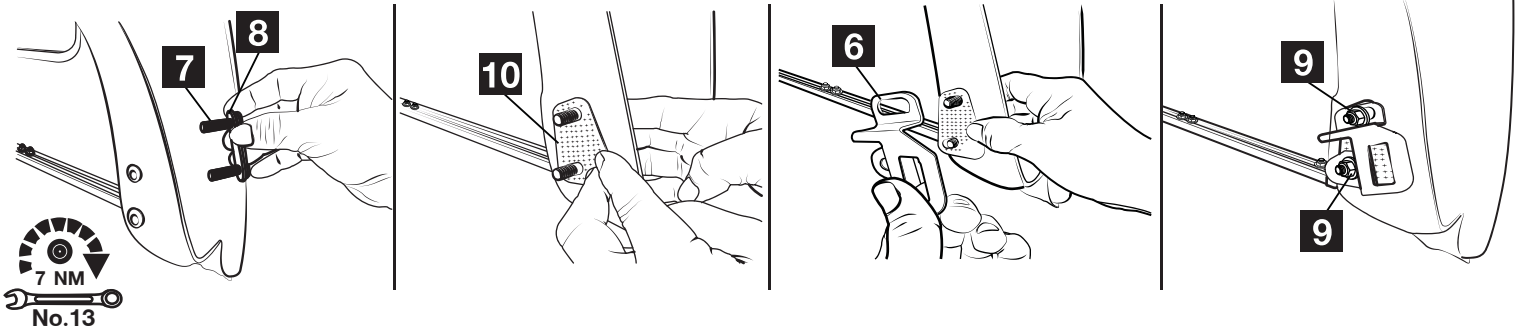

### 7 Adjust a latch R/L for matching with the slam lock on the rear door.

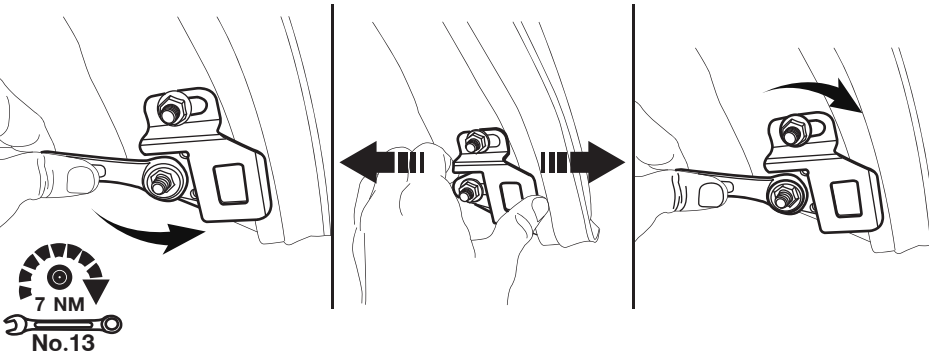

### 8 Shock absorber assembly.

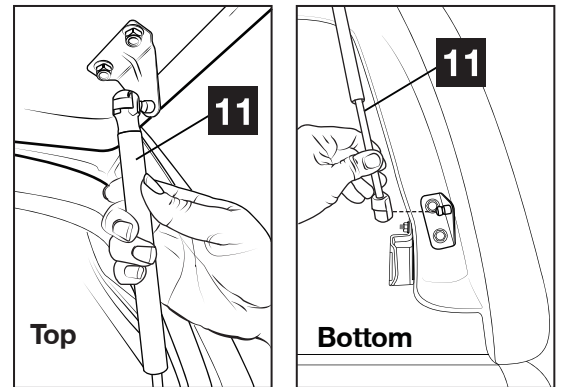

### 9 Final check the appearance.

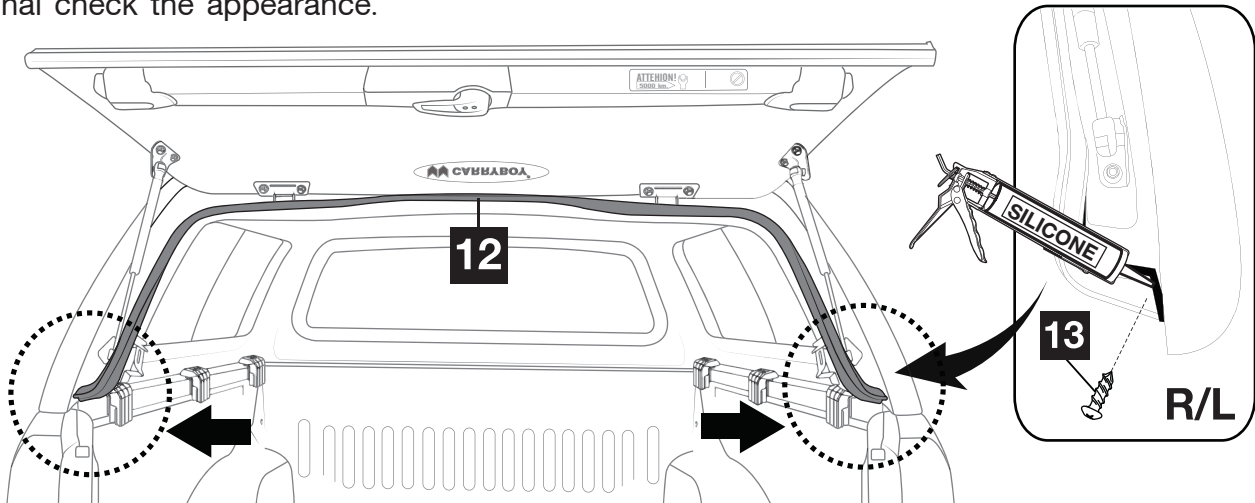

### 10 Stick CARRYBOY resin sticker R/L.

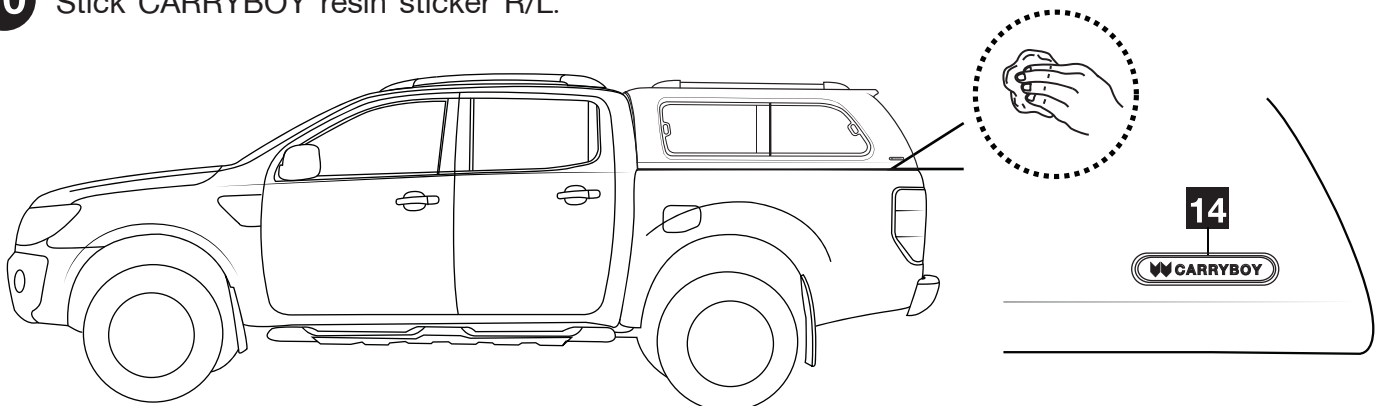

## Wiring diagram (Front harness)

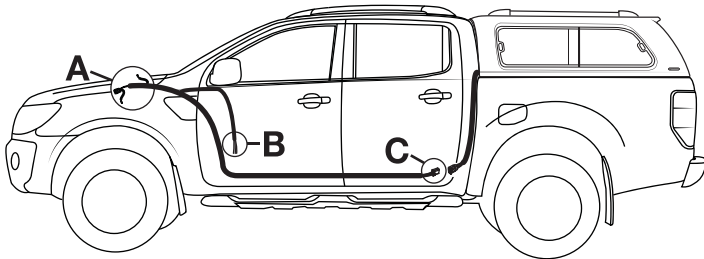

- C-090432-02**
- Brake
  - Room Lamp
  - Remote
  - Defogger

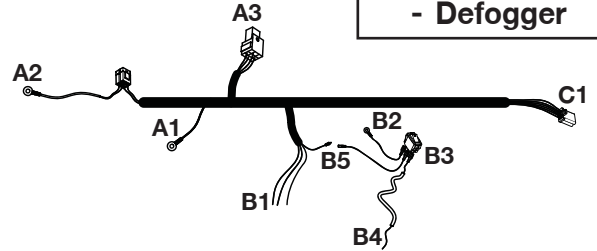

### Detail A

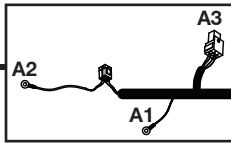

The notch area - the power cord.

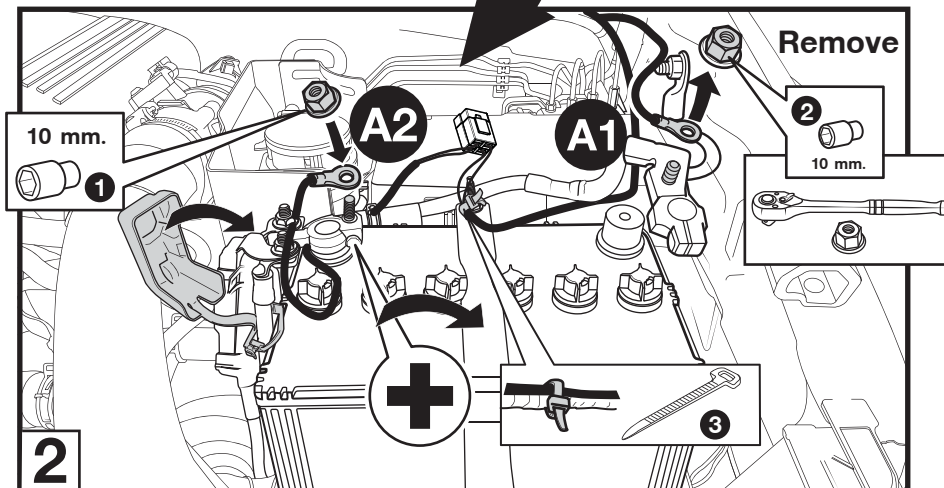
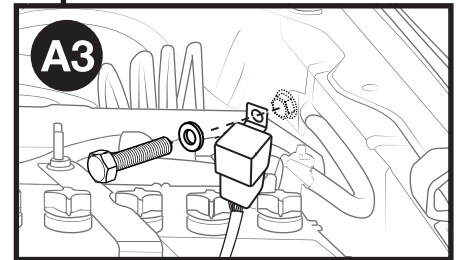
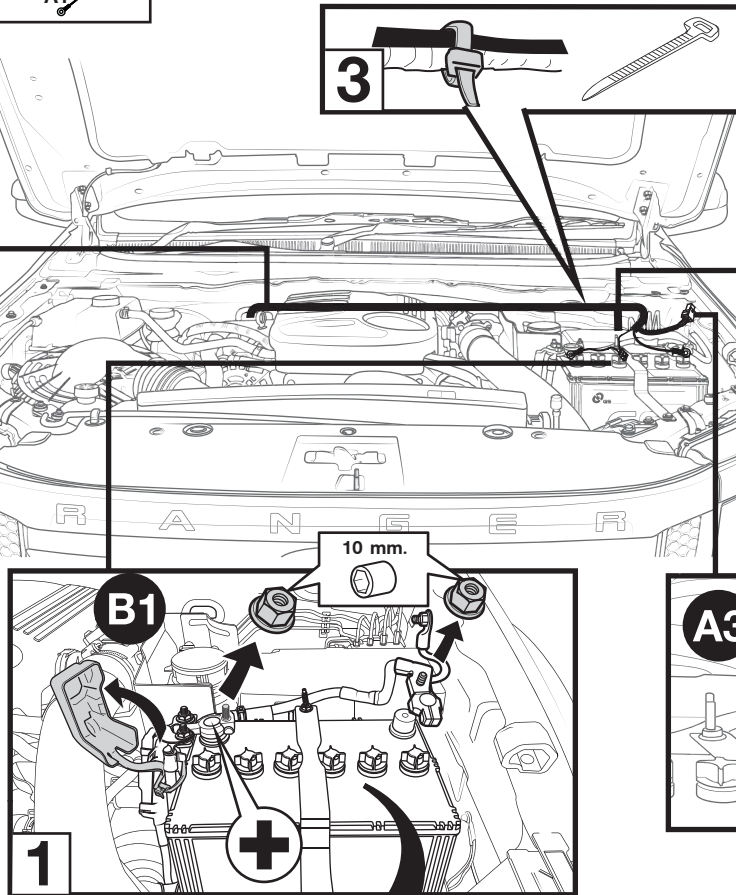
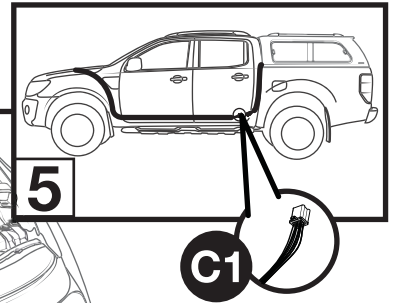
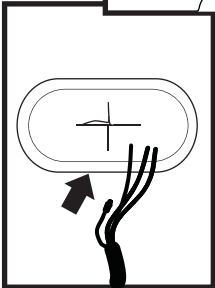
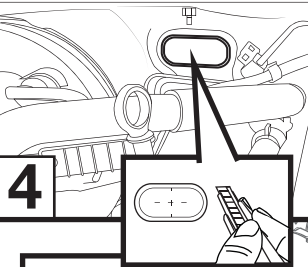



### Detail B

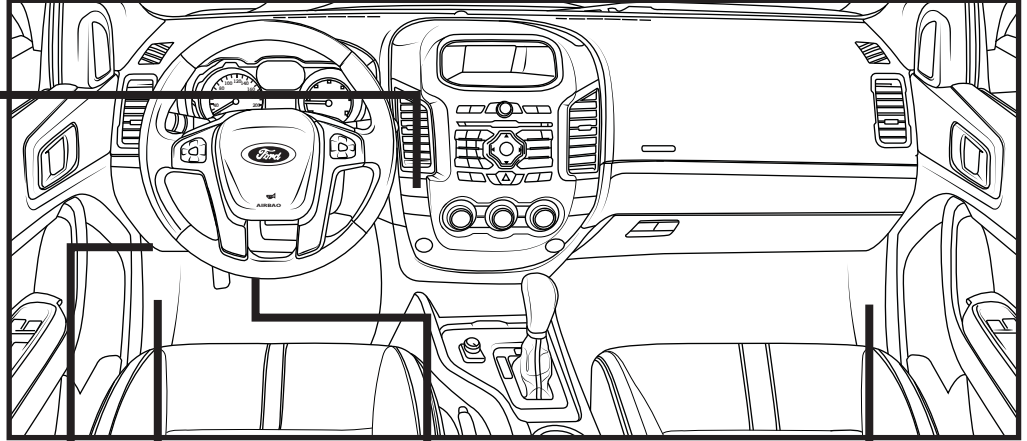
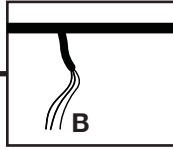

#### Defogger Wiring Method

Remove the front console to install the defogger switch. Insert through the defogger switch from the back to the front console and plug it back properly.

**B3**

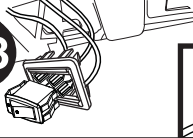

**B5**

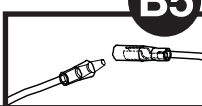

Vehicle	Car	Canopy
Defogger	Brack	White
Brake	Purple-White	Blue
Unlock	Purple-Green	Light blue
Lock	Gray-Bronze	Green

#### Ground

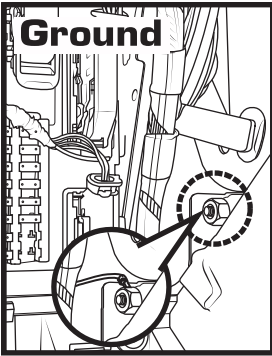

#### Unlock/Lock

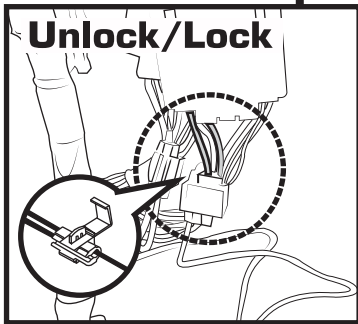

#### Brake

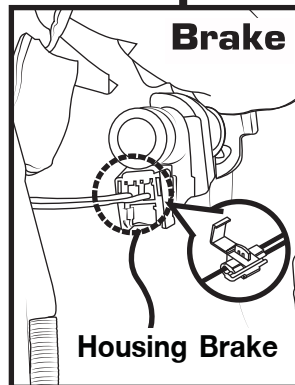

#### Defogger

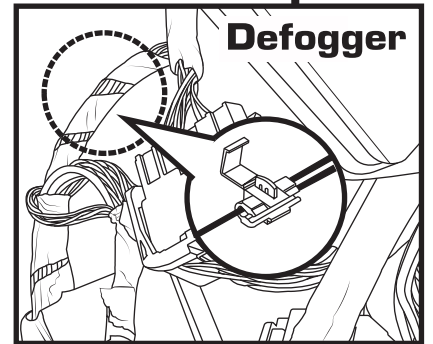

### Detail C

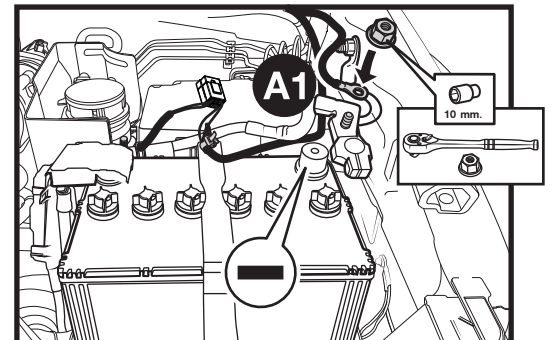
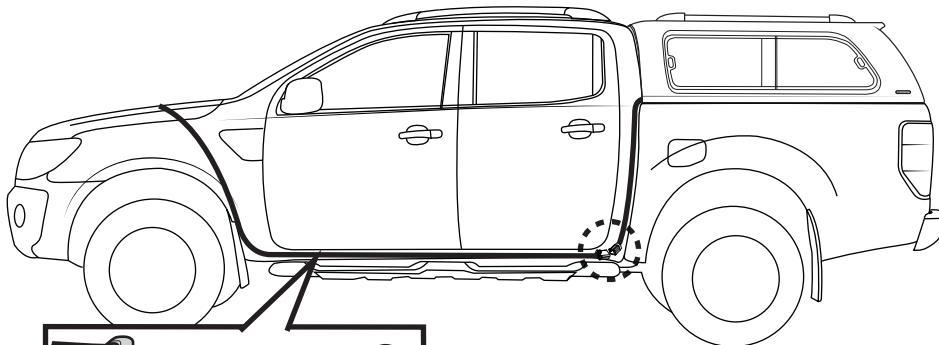
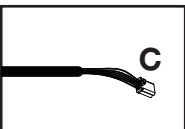

### Connection wiring harness to the wiring hardtop

Wiring harness

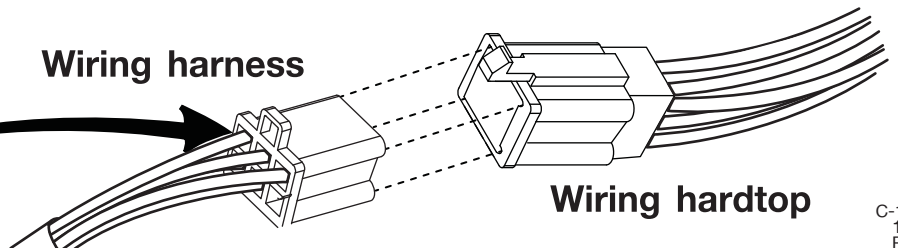

Wiring hardtop

- DETAIL A
- ① Black 1.50 SQMM
  - ② Red 1.25 SQMM
  - ③ Green 0.5 SQMM
  - ④ Yellow 0.5 SQMM
  - ⑤ Blue 0.5 SQMM
  - ⑥ White 0.5 SQMM
- BACK VIEW

## Wiring diagram (Rear harness)

C-090437-06

- Brake
- Room Lamp
- Remote
- Defogger

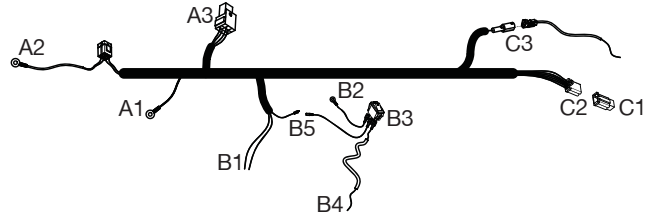
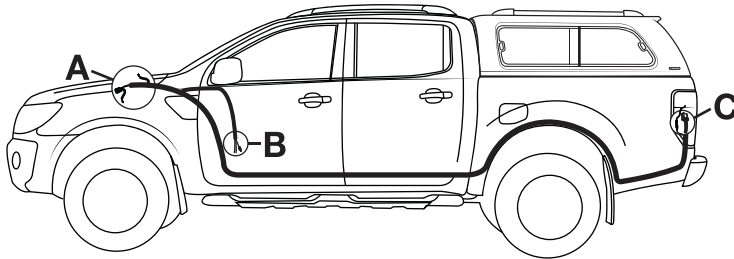

### Detail A

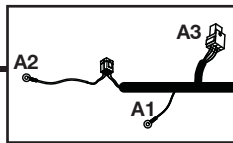

The notch area - the power cord.

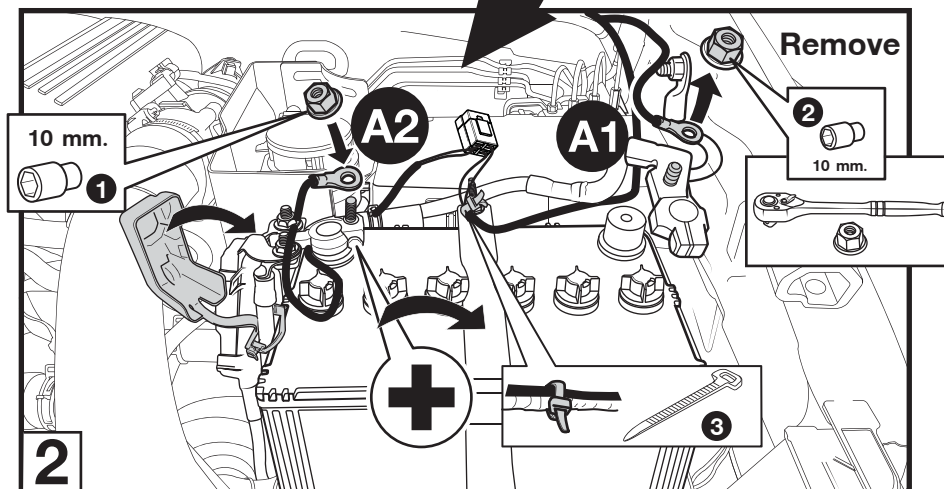
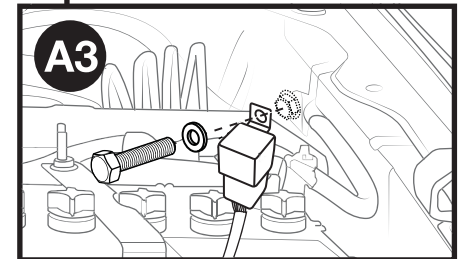
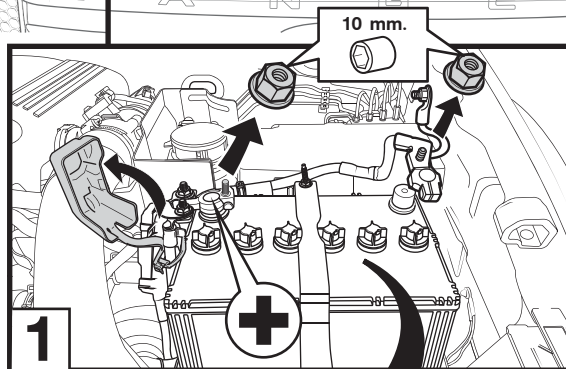
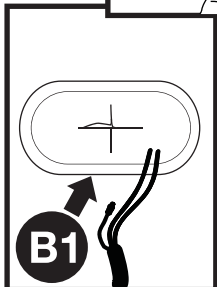
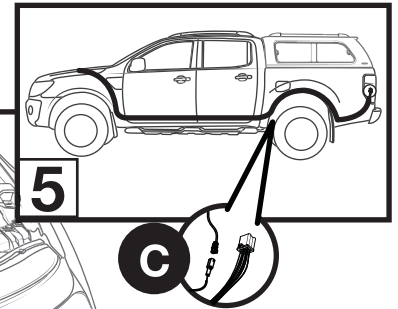
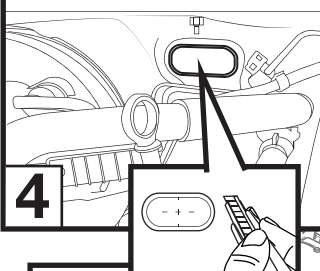

### Detail B

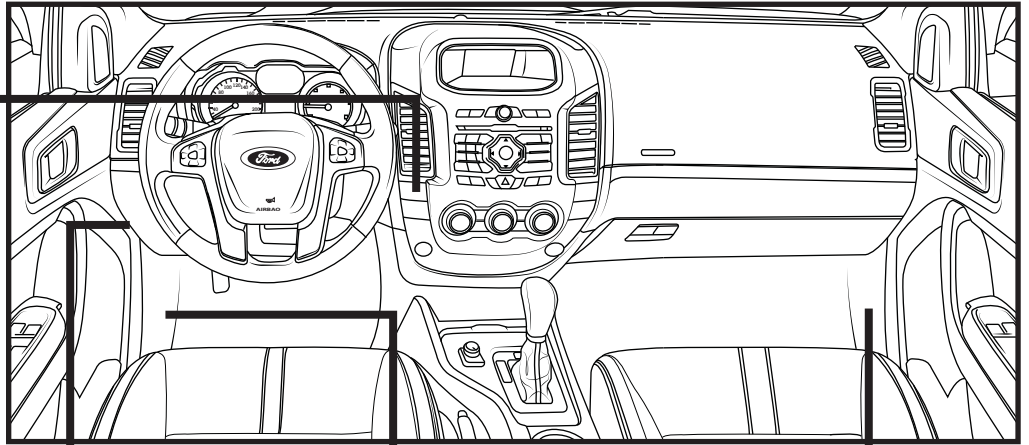
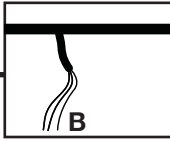

#### Defogger Wiring Method

Remove the front console to install the defogger switch. Insert through the defogger switch from the back to the front console and plug it back properly.



Vehicle	Car	Canopy
Defogger	Brack	White
Brake	Purple-White	Blue
Unlock	Purple-Green	Light blue
Lock	Gray-Bronze	Green

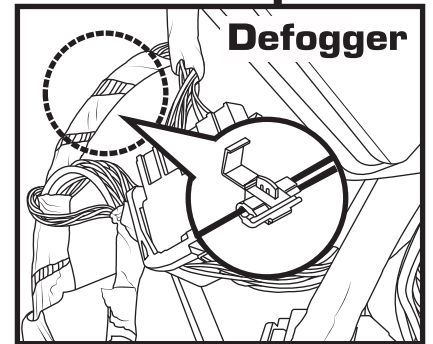
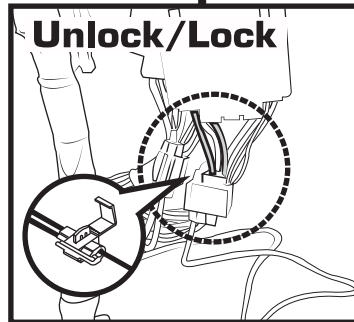
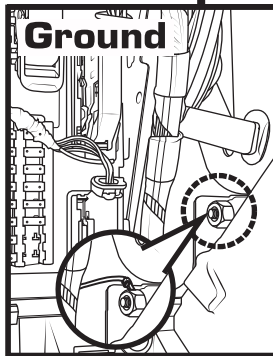

### Detail C

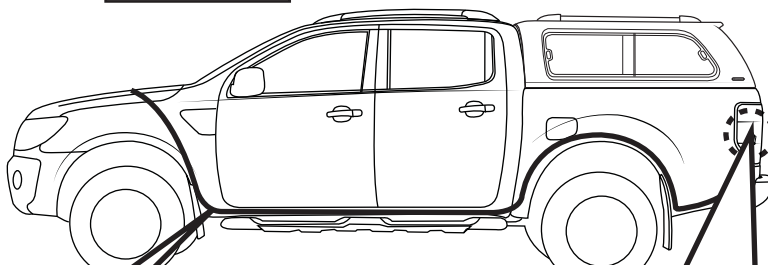
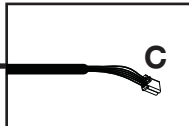

Remove taillamp (RH/LH)



Car electric line

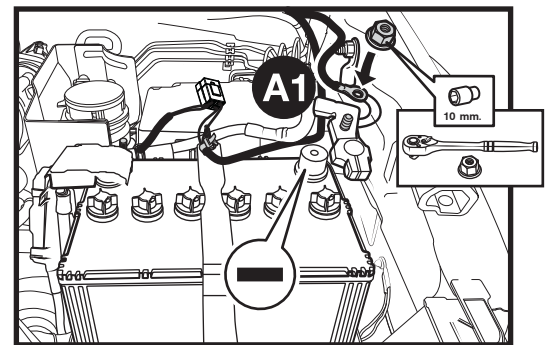
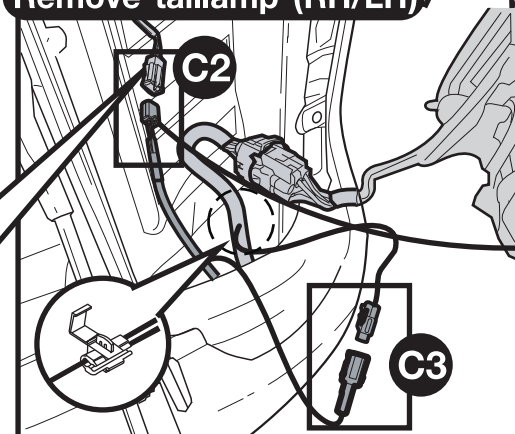
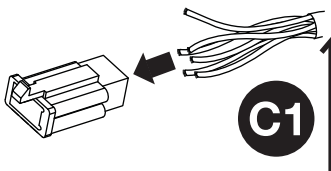

#### DETAIL A

- ① Black 1.50 SQMM
- ② Red 1.25 SQMM
- ③ Green 0.5 SQMM
- ④ Yellow 0.5 SQMM
- ⑤ Blue 0.5 SQMM
- ⑥ White 0.5 SQMM

BACK VIEW